

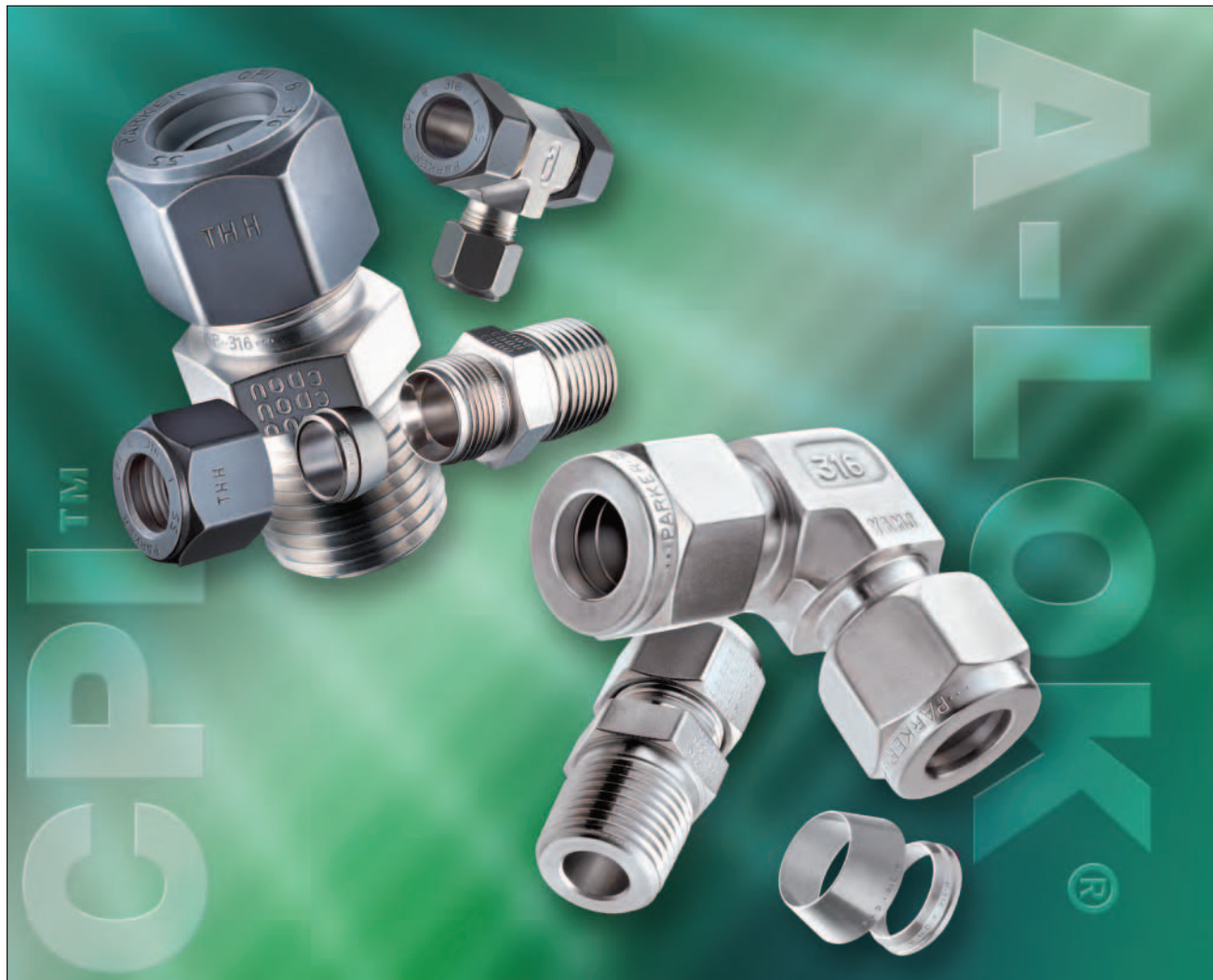

# **CPI™/A-LOK® Tube Fittings**

*Catalog 4230/4233  
April 2005*



## Introduction

Parker CPI™/A-LOK® Instrumentation Tube Fittings are designed as leak-free connections for process, power and instrumentation applications. These single and two ferrule fittings are manufactured to the highest quality standards and are available in a broad range of sizes, materials and configurations.

## Features

The Parker CPI™/A-LOK® tube fitting has been specifically designed for use on instrumentation, process and control systems, analysers and environmental equipment employed in chemical, petroleum, power generating and pulp and paper plants. The CPI™/A-LOK® tube fitting has also found extensive application in other fields where a high quality tube fitting is required.

## Materials

Parker CPI™/A-LOK® fittings are available as standard in Heat Code Traceable, 316 stainless steel. Other standard materials include steel, brass, aluminum, nickel-copper, Hastelloy C®, Alloy 600, Titanium, 6Mo, Incoloy 625 and 825. Straight fittings are machined from cold finished bar stock and shaped bodies are machined from close grain forgings. The raw materials used fully conform to the chemical requirements listed in Specification Table 1. For nuclear and other critical applications, stainless steel CPI™/A-LOK® fittings are readily available with documented heat code traceability.

## Pipe Fittings/Adapters

Parker CPI™/A-LOK® tube fittings are available in a wide variety of ISO and ANSI pipe thread configurations. For a full line of these fittings, see Catalog 4260.

## Tubing

Parker CPI™/A-LOK® tube fittings can be used with a wide variety of tubing materials and a broad range of tube wall thicknesses. CPI™/A-LOK® seals equally well on both thin wall and heavy wall tubing. **Tubing and fitting materials should be selected to be compatible with the fluid media. Due to thermal expansion characteristics and chemical stability, the tubing should be of the same material as the fitting. (The exception is brass fittings and copper tubing.)**

## Torque

Parker CPI™/A-LOK® tube fittings do not twist the tubing during installation. CPI™/A-LOK® ferrule designs assure that all make and remake motion is transmitted axially to the tubing. Since no radial movement of the tubing occurs, the tubing is not stressed. The mechanical integrity of the tubing is maintained.

## No Distortion

In make-up, there is no undue force in an outward direction to distort the fitting body or ferrules to cause interference between the ferrules and nut. This assures that the nut will back-off freely for disassembly and permits a greater number of easy remakes.

## Sealing

Positive, reliable connections with Parker CPI™/A-LOK® fittings have been qualified by exhaustive tests and over four decades of experience in the manufacture of quality tube fittings.

## Nomenclature

Parker CPI™/A-LOK® fittings part numbers are constructed from symbols that identify the size and style of the fitting and material used.

## Assembly, Remake, Gaugeability

**Proper assembly is the key component to a leak-free system. CPI™/A-LOK® tube fitting assembly, remake and gaugeability instructions are found on page 74 of this catalog.**

## Pressure Rating & Tubing Selection

For working pressures of CPI™/A-LOK® tube connections, please see the Instrument Tubing Selection Guide (4200-TS), found in the Technical Section of your Parker Instrumentation Products Process Binder, or the Parker Instrument Tube Fitting Installation Manual (Bulletin 4200-B4) at the end of this catalog.

In some cases where a male or female pipe thread is the second end of a Parker CPI™/A-LOK® fitting, such threads may be the pressure limiting factor of the tubing system. **Pressure ratings for Pipe Ends are shown on page 78.**



Huntsville, Alabama, USA



Barnstaple, UK

The Parker CPI™/A-LOK® fittings consists of precision engineered parts designed to provide secure leak-proof joints capable of satisfying high pressure, vacuum and vibration applications.

## Inch — CPI™

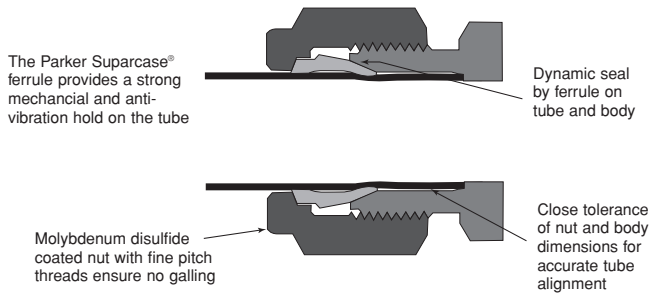

## Inch — A-LOK®

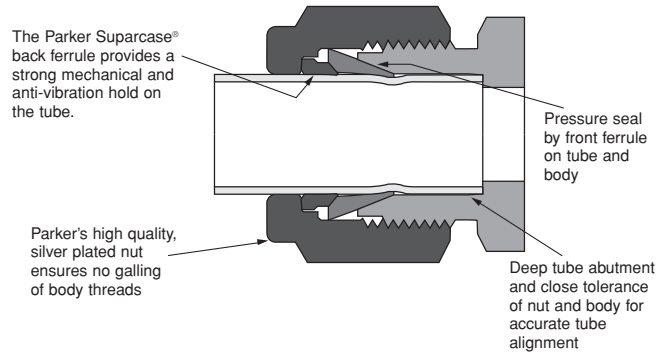

## Metric — CPI™

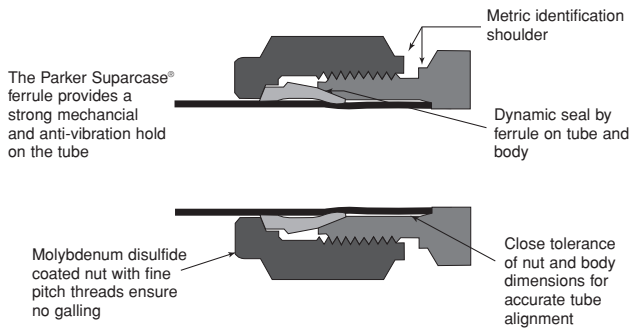

## Metric — A-LOK®

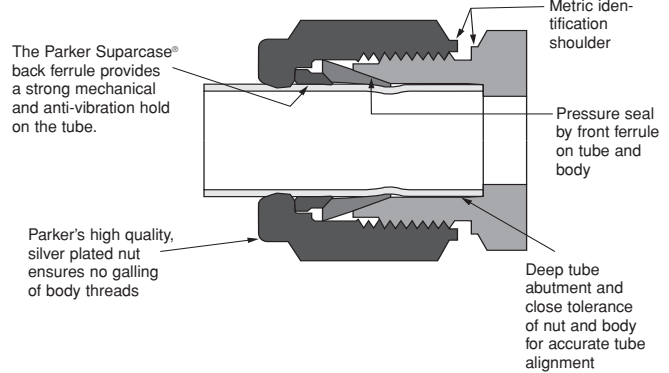

Parker Instrumentation Tube Fittings are supplied complete and ready to use. The ferrule(s) swage onto the tube as it moves down the body seat creating a pressure/vacuum-tight seal on both tube and body by the interface pressure and surface finish of mating components. The Parker Supracase® ferrule (back-ferrule only on A-LOK) creates a strong mechanical hold on the tube.

### WARNING

FAILURE, IMPROPER SELECTION OR IMPROPER USE OF THE PRODUCTS AND/OR SYSTEMS DESCRIBED HEREIN OR RELATED ITEMS CAN CAUSE DEATH, PERSONAL INJURY AND PROPERTY DAMAGE.

This document and other information from Parker Hannifin Corporation, its subsidiaries and authorized distributors provide product and/or system options for further investigation by users having technical expertise. It is important that you analyze all aspects of your application and review the information concerning the product or system in the current product catalog. Due to the variety of operating conditions and applications for these products or systems, the user, through its own analysis and testing, is solely responsible for making the final selection of the products and systems and assuring that all performance, safety and warning requirements of the application are met.

The products described herein, including without limitation, product features, specifications, designs, availability and pricing, are subject to change by Parker Hannifin Corporation and its subsidiaries at any time without notice.

### Offer of Sale

The items described in this document are hereby offered for sale by Parker Hannifin Corporation, its subsidiaries or its authorized distributors. This offer and its acceptance are governed by the provisions stated in the "Offer of Sale".

## Visual Index

### Tube to Male Pipe

FBZ, MSCN, MSCK, MSCR  
Male Connector  
pages 8, 9, 10, 11, 12



FH2BZ, MBCN  
Male Bulkhead Connector  
page 13



FH4BZ, MTCN  
Thermocouple Connector  
page 14



CBZ, MSELN, MSELK  
Male Elbow  
pages 14, 15, 16

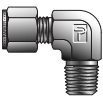

VBZ, MVELN  
NPT Male 45° Elbow  
page 17



RBZ, MRTN  
NPT Male Run Tee  
page 18



SBZ, MBTN  
NPT Male Branch Tee  
page 19



### Tube to Female Pipe

GBZ, FSCN, FSCK  
Female Connector  
pages 20, 21



GH2BZ, FBCN  
Female Bulkhead Connector  
page 22



GBZ, FSC GC  
Gauge Connector  
pages 22, 23



DBZ, FELN  
Female Elbow  
page 23



MBZ, FRTN  
Female Run Tee  
page 24



OBZ, FBTN  
Female Branch Tee  
page 25



### Tube to Tube Unions

HBZ, SC, SCM  
Union  
page 26



HBZ, CU  
Conversion Union  
page 27



HBZ, RU, RUM  
Reducing Union  
page 27



WBZ, BC, BCM  
Bulkhead Union  
page 28



DEBTA, DELTA  
Dielectric Union Adapter, Dielectric Assembly  
page 29



EBZ, EE, EEM, ELZ  
Union Elbow  
pages 29, 30



JBZ, ET, ETM  
Union Tee  
page 31



JBZ, JLZ  
Drop Size Tee  
page 32

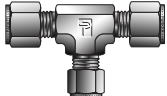

KBZ, ECR, ECRM  
Union Cross  
page 33



### Port Connectors

TRBZ, TUR, TUCM, TURM  
Tube End Reducer  
pages 34, 35, 36



T2H2B2, TUBC  
Tube End Bulkhead Adapter  
page 36

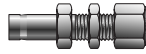

ZPC, PC, PCM  
Port Connector  
page 37



T2HF, MAN, MAR, MAK  
Tube End Male Adapter  
pages 38, 39, 40, 41



T2HOA, TUHA  
Tube End to SAE Straight Thread Adapter  
page 42



T2HG, FAN, FAK, FAR  
Tube End Female Adapter  
pages 42, 43, 44



P2T2, P2TU  
Push-Lok to Tube Adapter  
page 44



P2HF  
Push-Lok to Male Adapter  
page 45



P2BZ6, P2LZ6  
Push-Lok to CPI™/A-LOK®  
page 45



ZPB2, ZPC2  
Push-Lok to Port Connector  
page 45



LJFBZ, LJF  
Lapped Joint Tube Adaptors  
page 46



ZH2BZ, ZH2LX  
DP Transmitter Calibration Adapters  
page 46



### 37° Flare (AN) to CPI™/A-LOK®

X6HBZ6, X6TU  
37° Flare (AN) to CPI™/A-LOK®  
page 47



XHBZ, XASC  
37° Flare Connector to CPI™/A-LOK®  
page 47



XH2BZ, XABC  
37° Flare Bulkhead Connector to CPI™/A-LOK®  
page 47



### Tube to O-Ring Seal

ZHBA, M1SC  
Male Connector SAE Straight Thread  
page 49



C5BZ, M5SEL  
Male SAE Straight Thread Elbow  
page 50



CBZ (R), MSEL (R)  
Male BSPP Straight Thread Elbow  
page 50



R5BZ, M5RT  
Male Run Tee SAE Straight Thread  
page 51



**Visual Index**

RBZ (R),  
MRT (R)  
Male BSPP  
Run Tee  
Straight Thread  
page 51

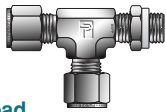

S5BZ, M5BT  
Male Branch  
Tee SAE  
Straight  
Thread  
page 52

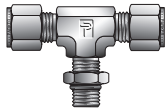

SBZ (R),  
MBT (R)  
Male BSPP  
Branch Tee  
Straight Thread  
page 52

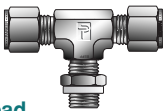

ZH3BA, ZH3LA  
Long Male  
Connector  
SAE Straight  
Thread  
page 53

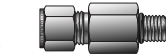

V5BZ, M5VEL  
45° Positionable  
Male Elbow  
page 53

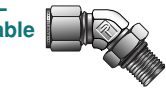

ZHBA5, M2SC  
Male Connector  
to O-Ring  
Straight Thread  
page 54



ZHBF5, M3SC  
Male Connector  
to O-Ring  
Pipe Thread  
page 54

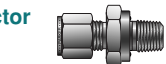

T2HOA5, M2TU  
Tube End to  
O-Ring Straight  
Thread  
page 55

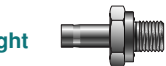

T2HOF5, M3TU  
Tube End to  
O-Ring Pipe  
Thread  
page 55

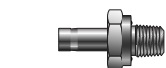

FHOA  
Pipe Thread to  
SAE Straight  
Thread Adapter  
page 56



AH2BZ, AH2LZ  
Bulkhead to  
Conversion  
Adapter  
page 56



**Tube to Welded  
Systems**

ZEBW, ZELW  
Socket Weld  
Elbow  
page 58

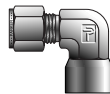

ZEBW2, ZELW2  
Buttweld Elbow  
page 58



ZHBW, ZHLW  
Socket Weld  
Connector  
page 59



ZHBW2, ZHLW2  
Buttweld  
Connector  
page 59, 60



**Analytical Fittings**

Z2HCZ7, Z2HLZ7  
Column End  
Fitting  
page 62



Z3HCZ7, Z3HLZ7  
Column End  
Fitting  
page 62



ZHCZ7, ZHLZ7  
Column End  
Fitting  
(without Frit)  
page 63



Z2HCZ, Z2HLZ  
Column End Fitting  
page 63



ZHCZ, ZHLZ  
Column End  
Fitting  
(without Frit)  
page 64



Z7HBZ7,  
Z7HLZ7  
Union  
Connector  
page 64



FBZ7, FLZ7  
Male Connector  
page 65



ZHBS, ZHLS  
Sanitary  
Flange Fitting  
page 65



**Barbed Fittings**

B2HF  
Barbed  
Connector to  
Male Pipe  
page 66



B2HT2, B2TU  
Barbed  
Connector to  
Tube Adapter  
page 66



HCS  
Hose Connector  
Sleeve  
page 66



**Components**

TIZ Insert  
page 67



BZ, NU, NUM  
Tube Nut  
page 67, 68



TZ Ferrules  
page 68



BZI Inverted  
Tube Nut  
page 68



BZP Knurled Nut  
page 68



FF, FFM  
Front Ferrules  
page 69



BF, BFM  
Back Ferrules  
page 69



Ferrule  
Holder  
page 69



FNZ, BLP, BLPM  
Plug  
page 70



PNBZ, BLEN,  
BLENM Cap  
page 70, 71



MDF  
Vent Protector  
page 71



Sealing Washers  
page 72



WLZ, WLN  
Bulkhead Locknut  
page 73



BN Bulkhead  
Locknut  
page 73



L5N Accessory  
Locknut  
page 73



Engineering Report  
page 74

Instrument Tubing Selection  
Guide  
pages 75-78

Pipe End Pressure Ratings  
page 78

Thread and Tube End Size  
Charts (U.S.A./International)  
pages 79-81

## Table 1 – Typical Raw Material Specifications

BASIC FITTING MATERIAL	BAR STOCK	FORGING	COMMON TUBING SPECIFICATION
BRASS	CA-360 QQ-B 626 Alloy 360 ASTM-B16 Alloy 360 CA-345 ASTM-B-453 Alloy 345	CA-377 QQ-B 626 Alloy 377 ASTM-B-124 Alloy 377 BS2872 CZ122	ASTM-B75 ASME-SB75 (TEMPER "O")
STAINLESS STEEL (Type 316) <sup>(1)</sup>	ASME-SA-479 Type 316-SS BS970 316-S31 DIN 4401 ASTM A276 Type 316	ASME-SA-182 316 BS970 316-S31 DIN 4401	ASME-SA-213 ASTM-A-213 ASTM-A-249 ASTM-A-269 <sup>(2)</sup> MIL T-8504 MIL T-8506
STEEL	ASTM-A-108 QQ-S-637	ASTM-A-576	SAE J524b SAE J525b ASTM-A-179
ALUMINUM	2017-T4 or 2024-T4 ASTM-B211 QQ-A-225/5 or 6	2014T (as fabricated) ASTM-B-211 QQ-A-225/4	303, 6061T6 ASTM-B-210
NICKEL-COPPER ALLOY 400	ASTM-B-164 QQ-N-281 BS3076 NA13	ASTM-B-164 QQ-N-281 BS3076 NA13	ASTM-B-165
HASTELLOY C-276®	ASTM-B-574 ASTMB575	ASTM-B-574	ASTM-B-622 ASTM-B-626
ALLOY 600	ASTM B-166 ASME-SB-166	ASTM-B-564	ASTM-B-163
CARPENTER 20®	ASTM-B-473	ASTM-B-462 ASTM-B-472	ASTM-B-468
TITANIUM	ASTM-B-348	ASTM-B-381	ASTM-B-338
INCOLOY ALLOY 625 INCOLOY ALLOY 825	BS3076 NA16 ASTMB425	BS3076 NA16 ASTMB425	ASTM-B-625 ASTM-B-444 ASTM-B-423 ASTM-B-829
6MO	UNS S31254 ASTM A479	UNS S31254 ASTM A 479	ASTM-A-269

(1) If more specific information, including heat code traceability, is required, your Parker Hannifin CPI™/A-LOK® distributor will provide details.  
 (2) Stainless steel CPI™/A-LOK® tube fittings work reliably on both seamless and welded-redrawn, fully annealed type 304, 316 and 316L tubing.

## Tube End Dimensional Data

SIZE NO.	INCHES					
	TUBE O.D.	STRAIGHT THREAD	†C	H HEX	E DIA.	†D TUBE INS. DEPTH
1	1/16	10-32	.43	5/16	.052	.34
2	1/8	5/16-20	.60	7/16	.093	.50
3	3/16	3/8-20	.64	1/2	.125	.54
4	1/4	7/16-20	.70	9/16	.187	.60
5	5/16	1/2-20	.73	5/8	.250	.64
6	3/8	9/16-20	.76	11/16	.281	.67
8	1/2	3/4-20	.87	7/8	.406	.90
10	5/8	7/8-20	.87	1	.500	.96
12	3/4	1-20	.87	1-1/8	.625	.96
14	7/8	1-1/8-20	.87	1-1/4	.750	1.03
16	1	1-5/16-20	1.05	1-1/2	.875	1.24
20	1-1/4	1-5/8-20	1.52	1-7/8	1.09	1.61
24	1-1/2	1-15/16-20	1.77	2-1/4	1.34	1.96
32	2	2-5/8-20	2.47	2-3/4	1.81	2.65

**NOTE:** Dimensions C and D are shown in the finger-tight position.

† Average Value

Dimensions for reference only, subject to change.

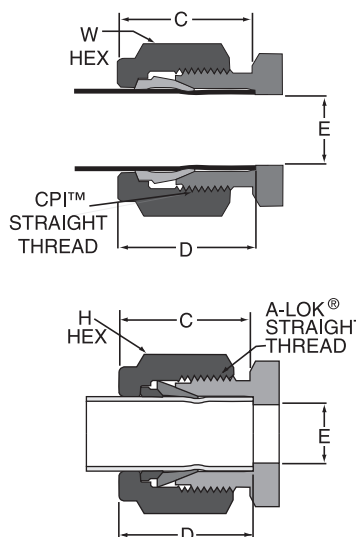

SIZE NO.	MILLIMETERS					
	TUBE O.D.	STRAIGHT THREAD	†C	H HEX	E DIA.	†D TUBE INS. DEPTH
2	2mm	5/16-20	15,3	12,0	1,7	12,9
3	3mm	5/16-20	15,3	12,0	2,4	12,9
4	4mm	3/8-20	16,1	12,0	2,4	13,7
6	6mm	7/16-20	17,7	14,0	4,8	15,3
8	8mm	1/2-20	18,6	15,0	6,4	16,2
10	10mm	5/8-20	19,5	18,0	7,9	17,2
12	12mm	3/4-20	22,0	22,0	9,5	22,8
14	14mm	7/8-20	22,0	24,0	11,1	24,4
15	15mm	7/8-20	22,0	24,0	11,9	24,4
16	16mm	7/8-20	22,0	24,0	12,7	24,4
18	18mm	1-20	22,0	27,0	15,1	24,4
20	20mm	1-1/8-20	22,0	30,0	15,9	26,0
22	22mm	1-1/8-20	22,0	30,0	18,3	26,0
25	25mm	1-5/16-20	26,5	35,0	21,8	31,3

**NOTE:** Dimensions C and D are shown in the finger-tight position.

† Average Value

Dimensions for reference only, subject to change.

## Nomenclature

Parker CPI™/A-LOK® tube fittings part numbers are constructed from symbols that identify the size and style of the fitting and material used.

**Example:** The part number shown below is for a Parker CPI™/A-LOK® stainless steel male connector for 1/2" O.D. tube (-8) and 1/4" male pipe thread (-4).

### How To Order CPI™ Inch Parts

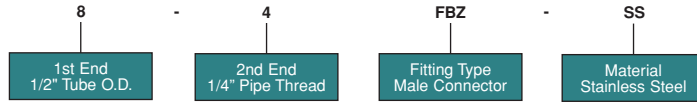

### How To Order A-LOK® Inch Parts

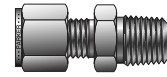
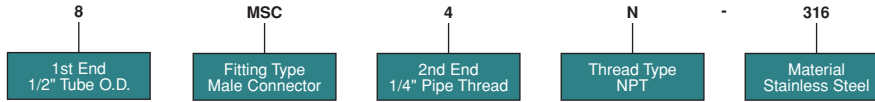

Parker CPI™/A-LOK® Tube Fittings are ordered by part number as listed in this catalog.

**Size:** Tube and pipe thread sizes are designed by the number of sixteenths of an inch (1/2" tube = 8/16" = 8) (1/4" pipe thread = 4/16" = 4).

**Straights & Elbows:** Call out largest CPI™/A-LOK® tube end size first followed by the smaller CPI™/A-LOK® tube end or pipe thread size.

**Tees & Crosses:** For drop size tees – first size the run (1 to 2) and then branch (3). Example – the size designator for a male run tee for 3/8" O.D. tube and 1/4" male pipe thread would be 6-4-6. For crosses – first size the run (1 to 2) and then the branch (3 to 4). For tees with all ends the same, use the tube and size before and after the style designator; i.e. 4-4-4 JBZ (CPI™), 4ET4 (A-LOK®).

**Type:** A letter or combination of letters and numbers are used to designate the type of fitting. (i.e. SBZ or MBT = male branch tee, GBZ or FA = female adapter, etc.) [See the visual index](#) for fitting types.

**Material:** Basic material type (B = brass, SS or 316 = stainless steel, type 316; S = steel; A = aluminum; M = Alloy 400; HC = Hastelloy C-276®; IN = Alloy 600; SS20 = Carpenter 20®; 6MO = 6Mo; 625 = 625; 825 = 825; T = Titanium). Parker CPI™/A-LOK® Tube fittings, for special applications, can be furnished in almost any material suitable for machining.

**Special Fittings:** If there is any question as to the fitting desired, particularly for special fitting configurations, it is suggested that a customer print be submitted with the fitting request for quote.

**Availability:** Items priced in current price list 4230/4233 are carried in stock. Price and delivery for non-stocked items quoted on request through the Quick Response Department.

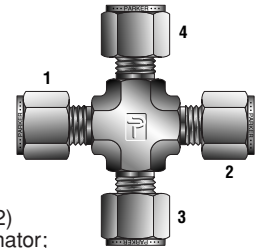

### How To Order CPI™ Metric Parts

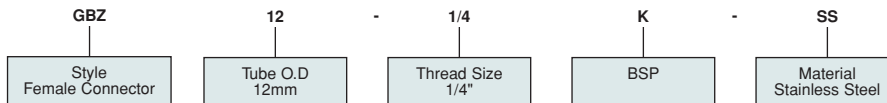

### How To Order A-LOK® Metric Parts

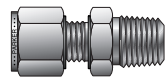
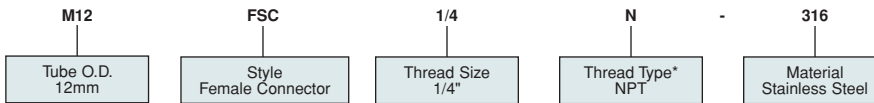

Parker CPI™/A-LOK® Tube Fittings are ordered by part number as listed in this catalog.

**Size:** Metric tube is designated in millimeters and prefixed "M" (i.e., 12mm tube - M12.) The pipe thread size is written as a fraction (i.e., 1/4 NPT = 1/4N).

**Straights & Elbows:** Call out largest CPI™/A-LOK® tube end size first followed by the smaller CPI™/A-LOK® tube end or pipe thread size.

**Tees & Crosses:** For drop size tees – first size the run (1 to 2) and then branch (3). Example – the size designator for a male run tee for 6mm tube and 1/4" male pipe thread would be 6-4-6. For crosses – first size the run (1 to 2) and then the branch (3 to 4). For tees with all ends the same, use the tube end size after the style designator; i.e. JBZ 4-4-4 JBZ (CPI™), ETM4 (A-LOK®).

**Type:** A letter or combination of letters and numbers are used to designate the type of fitting. [See the visual index](#) for fitting types.

**Material:** Basic material type (B = brass, SS or 316 = stainless steel, type 316; S = steel; A = aluminum; M = Alloy 400; HC = Hastelloy C-276®; IN = Alloy 600; SS20 = Carpenter 20®; 6MO = 6Mo; 625 = 625; 825 = 825; T = Titanium). Parker CPI™/A-LOK® Tube fittings, for special applications, can be furnished in almost any material suitable for machining.

### Thread Types:

N = NPT	ANSI B1.20.1
K = BSP Taper	BS21, ISO7/1
R = BSPP	BS2779, ISO 228/1+2, DIN 3852 FORM A
BR = BSPP	BS2779, ISO 228/1+2, DIN 3852 FORM B
M = Metric	ISO 6149-2
R-ED = BSPP	BS2779, ISO 228/1+2, DIN 3852 with elastic sealing

Please see the Visual Index.

**Availability:** Items priced in current price list 4230/4233 are carried in stock. Price and delivery for non-stocked items quoted on request through the Quick Response Department.

Note: Hastelloy C-276 is a registered trademark of Cabot Corporation. Carpenter 20 is a registered trademark of Carpenter Technology Corporation.

## Color Coding

For easy reference, table heads are color indicated as follows:

### fractional



### metric



## FBZ, MSCN NPT Male Connector For fractional tube

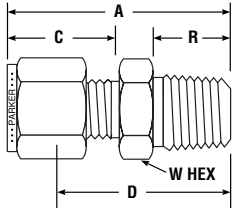
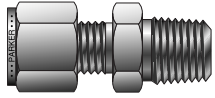

CPI™ PART NO.	A-LOK® PART NO.	INTER- CHANGES WITH	INCHES						
			TUBE O. D.	NPT PIPE THREAD	A	C	D	R	W HEX
1-1 FBZ	1MSC1N	100-1-1	1/16	1/16	.93	.43	.78	.38	5/16
1-2 FBZ	1MSC2N	100-1-2	1/16	1/8	1.03	.43	.88	.38	7/16
1-4 FBZ	1MSC4N	100-1-4	1/16	1/4	1.23	.43	1.08	.56	9/16
2-1 FBZ	2MSC1N	200-1-1	1/8	1/16	1.17	.60	.91	.38	3/8
2-2 FBZ	2MSC2N	200-1-2	1/8	1/8	1.20	.60	.94	.38	7/16
2-4 FBZ	2MSC4N	200-1-4	1/8	1/4	1.40	.60	1.14	.56	9/16
2-6 FBZ	2MSC6N	200-1-6	1/8	3/8	1.42	.60	1.16	.56	11/16
2-8 FBZ	2MSC8N	200-1-8	1/8	1/2	1.67	.60	1.41	.75	7/8
3-1 FBZ	3MSC1N	300-1-1	3/16	1/16	1.23	.64	.97	.38	7/16
3-2 FBZ	3MSC2N	300-1-2	3/16	1/8	1.23	.64	.97	.38	7/16
3-4 FBZ	3MSC4N	300-1-4	3/16	1/4	1.43	.64	1.17	.56	9/16
4-1 FBZ	4MSC1N	400-1-1	1/4	1/16	1.29	.70	1.00	.38	1/2
4-2 FBZ	4MSC2N	400-1-2	1/4	1/8	1.29	.70	1.00	.38	1/2
4-4 FBZ	4MSC4N	400-1-4	1/4	1/4	1.49	.70	1.20	.56	9/16
4-6 FBZ	4MSC6N	400-1-6	1/4	3/8	1.51	.70	1.22	.56	11/16
4-8 FBZ	4MSC8N	400-1-8	1/4	1/2	1.76	.70	1.47	.75	7/8
4-12 FBZ	4MSC12N	400-1-12	1/4	3/4	1.82	.70	1.53	.75	1-1/16
5-2 FBZ	5MSC2N	500-1-2	5/16	1/8	1.34	.73	1.05	.38	9/16
5-4 FBZ	5MSC4N	500-1-4	5/16	1/4	1.52	.73	1.23	.56	9/16
5-6 FBZ	5MSC6N	500-1-6	5/16	3/8	1.55	.73	1.25	.56	11/16
5-8 FBZ	5MSC8N	500-1-8	5/16	1/2	1.79	.73	1.5	.75	7/8
6-2 FBZ	6MSC2N	600-1-2	3/8	1/8	1.38	.76	1.09	.38	5/8
6-4 FBZ	6MSC4N	600-1-4	3/8	1/4	1.57	.76	1.28	.56	5/8
6-6 FBZ	6MSC6N	600-1-6	3/8	3/8	1.57	.76	1.28	.56	11/16
6-8 FBZ	6MSC8N	600-1-8	3/8	1/2	1.82	.76	1.53	.75	7/8
6-12 FBZ	6MSC12N	600-1-12	3/8	3/4	1.88	.76	1.59	.75	1-1/16
8-2 FBZ	8MSC2N	810-1-2	1/2	1/8	1.53	.87	1.13	.38	13/16
8-4 FBZ	8MSC4N	810-1-4	1/2	1/4	1.71	.87	1.31	.56	13/16
8-6 FBZ	8MSC6N	810-1-6	1/2	3/8	1.71	.87	1.31	.56	13/16
8-8 FBZ	8MSC8N	810-1-8	1/2	1/2	1.93	.87	1.53	.75	7/8
8-12 FBZ	8MSC12N	810-1-12	1/2	3/4	1.99	.87	1.59	.75	1-1/16
8-16 FBZ	8MSC16N	810-1-16	1/2	1	2.28	.87	1.88	.94	1-3/8
10-6 FBZ	10MSC6N	1010-1-6	5/8	3/8	1.74	.87	1.34	.56	15/16
10-8 FBZ	10MSC8N	1010-1-8	5/8	1/2	1.93	.87	1.53	.75	15/16
10-12 FBZ	10MSC12N	1010-1-12	5/8	3/4	1.99	.87	1.59	.75	1-1/16
12-8 FBZ	12MSC8N	1210-1-8	3/4	1/2	1.99	.87	1.59	.75	1-1/16
12-12 FBZ	12MSC12N	1210-1-12	3/4	3/4	1.99	.87	1.59	.75	1-1/16
12-16 FBZ	12MSC16N	1210-1-16	3/4	1	2.28	.87	1.88	.94	1-3/8
14-12 FBZ	14MSC12N	1410-1-12	7/8	3/4	1.99	.87	1.59	.75	1-3/16
14-16 FBZ	14MSC16N	1410-1-16	7/8	1	2.28	.87	1.88	.94	1-3/8
16-8 FBZ	16MSC8N	1610-1-8	1	1/2	2.27	1.05	1.78	.75	1-3/8
16-12 FBZ	16MSC12N	1610-1-12	1	3/4	2.27	1.05	1.78	.75	1-3/8
16-16 FBZ	16MSC16N	1610-1-16	1	1	2.46	1.05	1.97	.94	1-3/8
20-20 FBZ	20MSC20N	2010-1-20	1-1/4	1-1/4	3.03	1.52	2.17	.97	1-3/4
24-24 FBZ	24MSC24N	2410-1-24	1-1/2	1-1/2	3.50	1.77	2.44	1.00	2-1/8
32-32 FBZ	32MSC32N	3210-1-32	2	2	4.47	2.47	3.00	1.04	2-3/4

NOTE: A and C dimensions are typical finger-tight.

Dimensions for reference only, subject to change.

Sizes 20, 24, 32 require additional lubrication to assembly.

### Color Coding

For easy reference, table heads are color indicated as follows:

fractional



metric

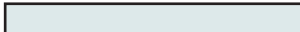



## FBZ, MSCN NPT Male Connector For metric tube

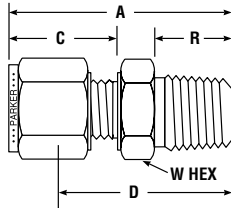
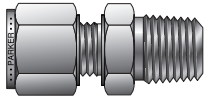

CPTM PART NO.	A-LOK® PART NO.	INTER- CHANGES WITH	TUBE O.D.	MILLIMETERS					
				NPT PIPE THREAD	A	C	D	R	W HEX
FBZ 2-1/8	M2MSC1/8N	2MO-1-2	2	1/8	29,7	15,3	23,1	9,5	12,0
FBZ 3-1/8	M3MSC1/8N	3MO-1-2	3	1/8	29,7	15,3	23,1	9,5	12,0
FBZ 3-1/4	M3MSC1/4N	3MO-1-4	3	1/4	35,3	15,3	28,7	14,3	14,0
FBZ 4-1/8	M4MSC1/8N	4MO-1-2	4	1/8	31,2	16,1	24,6	9,5	12,0
FBZ 4-1/4	M4MSC1/4N	4MO-1-4	4	1/4	36,3	16,1	29,7	14,3	14,0
FBZ 6-1/8	M6MSC1/8N	6MO-1-2	6	1/8	32,9	17,7	25,4	9,5	14,0
FBZ 6-1/4	M6MSC1/4N	6MO-1-4	6	1/4	38,1	17,7	30,6	14,3	14,0
FBZ 6-3/8	M6MSC3/8N	6MO-1-6	6	3/8	38,5	17,7	31,0	14,3	18,0
FBZ 6-1/2	M6MSC1/2N	6MO-1-8	6	1/2	44,8	17,7	37,3	19,1	22,0
FBZ 8-1/8	M8MSC1/8N	8MO-1-2	8	1/8	34,2	18,6	26,7	9,5	15,0
FBZ 8-1/4	M8MSC1/4N	8MO-1-4	8	1/4	38,8	18,6	31,3	14,3	15,0
FBZ 8-3/8	M8MSC3/8N	8MO-1-6	8	3/8	39,3	18,6	31,8	14,3	18,0
FBZ 8-1/2	M8MSC1/2N	8MO-1-8	8	1/2	45,6	18,6	38,1	19,1	22,0
FBZ 10-1/8	M10MSC1/8N	10MO-1-2	10	1/8	36,1	19,5	28,6	9,5	18,0
FBZ 10-1/4	M10MSC1/4N	10MO-1-4	10	1/4	40,9	19,5	33,3	14,3	18,0
FBZ 10-3/8	M10MSC3/8N	10MO-1-6	10	3/8	40,9	19,5	33,3	14,3	18,0
FBZ 10-1/2	M10MSC1/2N	10MO-1-8	10	1/2	47,5	19,5	38,9	19,1	22,0
FBZ 10-3/4	M10MSC3/4N	10MO-1-12	10	3/4	46,4	19,5	38,9	19,1	27,0
FBZ 10-1	M10MSC1N	10MO-1-16	10	1	55,0	19,5	47,5	23,8	35,0
FBZ 12-1/4	M12MSC1/4N	12MO-1-4	12	1/4	43,4	22,0	33,3	14,3	22,0
FBZ 12-3/8	M12MSC3/8N	12MO-1-6	12	3/8	43,4	22,0	33,3	14,3	22,0
FBZ 12-1/2	M12MSC1/2N	12MO-1-8	12	1/2	49,0	22,0	38,9	19,1	22,0
FBZ 12-3/4	M12MSC3/4N	12MO-1-12	12	3/4	50,5	22,0	40,4	19,1	27,0
FBZ 14-1/4	M14MSC1/4N	14MO-1-4	14	1/4	44,2	22,0	34,1	14,3	24,0
FBZ 14-3/8	M14MSC3/8N	14MO-1-6	14	3/8	44,2	22,0	34,1	14,3	24,0
FBZ 14-1/2	M14MSC1/2N	14MO-1-8	14	1/2	49,0	22,0	38,9	19,1	24,0
FBZ 15-1/2	M15MSC1/2N	15MO-1-8	15	1/2	49,0	22,0	38,9	19,1	24,0
FBZ 16-3/8	M16MSC3/8N	16MO-1-6	16	3/8	44,1	22,0	34,01	14,3	24,0
FBZ 16-1/2	M16MSC1/2N	16MO-1-8	16	1/2	49,0	22,0	38,9	19,1	24,0
FBZ 16-3/4	M16MSC3/4N	16MO-1-12	16	3/4	50,5	22,0	40,5	19,1	27,0
FBZ 18-1/2	M18MSC1/2N	18MO-1-8	18	1/2	50,6	22,0	40,5	19,1	27,0
FBZ 18-3/4	M18MSC3/4N	18MO-1-12	18	3/4	50,6	22,0	40,5	19,1	27,0
FBZ 20-1/2	M20MSC1/2N	20MO-1-8	20	1/2	50,6	22,0	42,2	19,1	30,0
FBZ 20-3/4	M20MSC3/4N	20MO-1-12	20	3/4	52,3	22,0	42,2	19,1	30,0
FBZ 20-1	M20MSC1N	20MO-1-16	20	1	57,7	22,0	47,6	23,8	35,0
FBZ 22-3/4	M22MSC3/4N	22MO-1-12	22	3/4	52,3	22,0	42,2	19,1	35,0
FBZ 24-1/2	M25MSC1/2N	25MO-1-8	25	1/2	57,5	26,5	45,3	19,1	35,0
FBZ 25-3/4	M25MSC3/4N	25MO-1-12	25	3/4	57,5	26,5	45,2	19,1	35,0
FBZ 25-1	M25MSC1N	25MO-1-16	25	1	62,3	26,5	50,0	23,8	35,0

NOTE: A and C dimensions are typical finger-tight.

Dimensions for reference only, subject to change.

## FBZ, MSCK BSP Taper Male Connector

*For fractional tube*

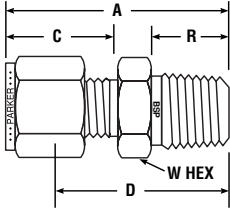
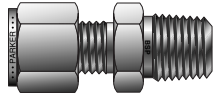

CPI™ PART NO.	A-LOK® PART NO.	INTER- CHANGES WITH	INCHES							
			TUBE O.D.	BSPT THREAD	A	C	D	R	W HEX	BORE
2-2K FBZ	2MSC2K	200-1-2RT	1/8	1/8	1.20	.60	.938	.38	7/16	.19
2-4K FBZ	2MSC4K	200-1-4RT	1/8	1/4	1.40	.60	1.14	.56	9/16	.19
4-2K FBZ	4MSC2K	400-1-2RT	1/4	1/8	1.30	.70	1.00	.38	1/2	.19
4-4K FBZ	4MSC4K	400-1-4RT	1/4	1/4	1.50	.70	1.20	.56	9/16	.19
4-6K FBZ	4MSC6K	400-1-6RT	1/4	3/8	1.52	.70	1.22	.56	11/16	.19
4-8K FBZ	4MSC8K	400-1-8RT	1/4	1/2	1.77	.70	1.47	.75	7/8	.19
5-2K FBZ	5MSC2K	500-1-2RT	5/16	1/8	1.34	.73	1.05	.38	9/16	.19
5-4K FBZ	5MSC4K	500-1-4RT	5/16	1/4	1.52	.73	1.23	.56	9/16	.19
6-2K FBZ	6MSC2K	600-1-2RT	3/8	1/8	1.39	.76	1.09	.38	5/8	.19
6-4K FBZ	6MSC4K	600-1-4RT	3/8	1/4	1.57	.76	1.28	.56	5/8	.28
6-6K FBZ	6MSC6K	600-1-6RT	3/8	3/8	1.57	.76	1.28	.56	11/16	.28
6-8K FBZ	6MSC8K	600-1-8RT	3/8	1/2	1.82	.76	1.53	.75	7/8	.28
8-4K FBZ	8MSC4K	810-1-4RT	1/2	1/4	1.69	.86	1.31	.56	13/16	.28
8-6K FBZ	8MSC6K	810-1-6RT	1/2	3/8	1.69	.86	1.31	.56	13/16	.38
8-8K FBZ	8MSC8K	810-1-8RT	1/2	1/2	1.91	.66	1.53	.75	7/8	.41

NOTE: A and C dimensions are typical finger-tight.

Dimensions for reference only, subject to change.

## FBZ, MSCK BSP Taper Male Connector

*For metric tube*

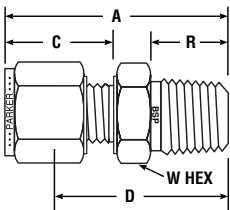
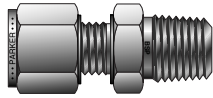

CPI™ PART NO.	A-LOK® PART NO.	INTER- CHANGES WITH	MILLIMETERS						
			TUBE O.D.	BSPT THREAD	A	C	D	R	W HEX
FBZ 2-1/8K	M2MSC1/8K	2MO-1-2RT	2	1/8	29,7	15,3	23,1	9,5	12,0
FBZ 3-1/8K	M3MSC1/8K	3MO-1-2RT	3	1/8	29,7	15,3	23,1	9,7	12,0
FBZ 3-1/4K	M3MSC1/4K	3MO-1-4RT	3	1/4	35,3	15,3	28,7	14,2	14,0
FBZ 4-1/8K	M4MSC1/8K	4MO-1-2RT	4	1/8	31,2	16,1	24,6	9,7	12,0
FBZ 4-1/4K	M4MSC1/4K	4MO-1-4RT	4	1/4	36,3	16,1	29,7	14,2	14,0
FBZ 6-1/8K	M6MSC1/8K	6MO-1-2RT	6	1/8	32,9	17,7	25,4	9,7	14,0
FBZ 6-1/4K	M6MSC1/4K	6MO-1-4RT	6	1/4	40,0	17,7	30,5	14,2	14,0
FBZ 6-3/8K	M6MSC3/8K	6MO-1-6RT	6	3/8	38,5	17,7	31,0	14,2	18,0
FBZ 6-1/2K	M6MSC1/2K	6MO-1-8RT	6	1/2	45,6	17,7	38,1	19,1	22,0
FBZ 8-1/8K	M8MSC1/8K	8MO-1-2RT	8	1/8	33,9	18,6	26,4	9,5	15,0
FBZ 8-1/4K	M8MSC1/4K	8MO-1-4RT	8	1/4	38,7	18,6	31,2	14,2	15,0
FBZ 8-3/8K	M8MSC3/8K	8MO-1-6RT	8	3/8	39,3	18,6	31,8	14,2	18,0
FBZ 8-1/2K	M8MSC1/2K	8MO-1-8RT	8	1/2	45,6	18,6	38,1	19,1	22,0
FBZ 10-1/8K	M10MSC1/8K	10MO-1-2RT	10	1/8	36,2	19,5	28,6	9,5	18,0
FBZ 10-1/4K	M10MSC1/4K	10MO-1-4RT	10	1/4	40,9	19,5	33,3	14,2	18,0
FBZ 10-3/8K	M10MSC3/8K	10MO-1-6RT	10	3/8	40,9	19,5	33,3	14,2	18,0
FBZ 10-1/2K	M10MSC1/2K	10MO-1-8RT	10	1/2	46,5	19,5	38,9	19,1	22,0
FBZ 12-1/4K	M12MSC1/4K	12MO-1-4RT	12	1/4	43,4	22,0	33,3	14,2	22,0
FBZ 12-3/8K	M12MSC3/8K	12MO-1-6RT	12	3/8	43,4	22,0	33,3	14,2	22,0
FBZ 12-1/2K	M12MSC1/2K	12MO-1-8RT	12	1/2	49,0	22,0	38,9	19,1	22,0
FBZ 12-3/4K	M12MSC3/4K	12MO-1-12RT	12	3/4	49,5	22,0	40,4	19,1	27,0
FBZ 15-1/2K	M15MSC1/2K	15MO-1-8RT	15	1/2	49,0	22,0	38,9	19,1	24,0
FBZ 16-3/8K	M16MSC3/8K	16MO-1-6RT	16	3/8	44,2	22,0	34,1	14,2	24,0
FBZ 16-1/2K	M16MSC1/2K	16MO-1-8RT	16	1/2	49,0	22,0	38,9	19,1	24,0
FBZ 16-3/4K	M16MSC3/4K	16MO-1-12RT	16	3/4	49,5	22,0	40,5	19,1	27,0
FBZ 18-1/2K	M18MSC1/2K	18MO-1-8RT	18	1/2	50,6	22,0	40,4	19,1	27,0
FBZ 18-3/4K	M18MSC3/4K	18MO-1-12RT	18	3/4	50,6	22,0	40,4	19,1	27,0
FBZ 20-1/2K	M20MSC1/2K	20MO-1-8RT	20	1/2	52,3	22,0	42,2	19,1	30,0
FBZ 20-3/4K	M20MSC3/4K	20MO-1-12RT	20	3/4	52,3	22,0	42,2	19,1	30,0
FBZ 22-3/4K	M22MSC3/4K	22MO-1-12RT	22	3/4	52,3	22,0	42,2	19,1	30,0
FBZ 25-3/4K	M25MSC3/4K	25MO-1-12RT	25	3/4	57,5	26,5	45,2	19,1	35,0
FBZ 25-1K	M25MSC1K	25MO-1-16RT	25	1	62,3	26,5	50,0	23,9	35,0

NOTE: A and C dimensions are typical finger-tight.

Dimensions for reference only, subject to change.

### Color Coding

For easy reference, table heads are color indicated as follows:

**fractional**



**metric**



## FBZ, MSCR BSPP Male Connector For fractional tube

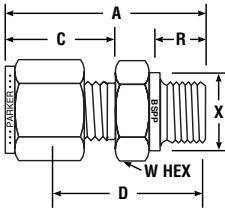
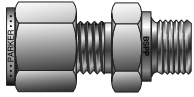

CPI™ PART NO.	A-LOK® PART NO.	INTER- CHANGES WITH	INCHES								
			TUBE O.D.	BSPP THREAD	A	C	D	R	X	W HEX	BORE
2-2R FBZ	2MSC2R	200-1-2RS	1/8	1/8	1.18	.60	.922	.28	.54	9/16	.16
2-4R FBZ	2MSC4R	200-1-4RS	1/8	1/4	1.27	.60	1.13	.44	.70	3/4	.09
2-6R FBZ	2MSC6R	200-1-6RS	1/8	3/8	1.46	.60	1.172	.44	.86	7/8	.28
4-2R FBZ	4MSC2R	400-1-2RS	1/4	1/8	1.28	.70	.98	.28	.54	9/16	.16
4-4R FBZ	4MSC4R	400-1-4RS	1/4	1/4	1.49	.70	1.19	.44	.70	3/4	.19
4-6R FBZ	4MSC6R	400-1-6RS	1/4	3/8	1.55	.70	1.25	.44	.86	7/8	.19
4-8R FBZ	4MSC8R	400-1-8RS	1/4	1/2	1.77	.70	1.47	.56	1.01	1-1/16	.19
6-2R FBZ	6MSC2R	600-1-2RS	3/8	1/8	1.35	.76	1.06	.28	.54	5/8	.16
6-4R FBZ	6MSC4R	600-1-4RS	3/8	1/4	1.54	.76	1.25	.44	.70	3/4	.25
6-6R FBZ	6MSC6R	600-1-6RS	3/8	3/8	1.57	.76	1.28	.44	.86	7/8	.28
6-8R FBZ	6MSC8R	600-1-8RS	3/8	1/2	1.82	.76	1.53	.56	1.01	1-1/16	.28
8-4R FBZ	8MSC4R	810-1-4RS	1/2	1/4	1.66	.86	1.28	.44	.70	13/16	.25
8-6R FBZ	8MSC6R	810-1-6RS	1/2	3/8	1.69	.86	1.31	.44	.86	7/8	.31
8-8R FBZ	8MSC8R	810-1-8RS	1/2	1/2	1.91	.86	1.53	.56	1.01	1-1/16	.41
12-8R FBZ	12MSC8R	1210-1-8RS	3/4	1/2	1.93	.86	1.531	.56	1.01	1-1/16	.41
12-12R FBZ	12MSC12R	1210-1-12RS	3/4	3/4	2.07	.86	1.69	.63	1.25	1-3/8	.63
16-8R FBZ	16MSC8R	1610-1-8RS	1	1/2	2.21	1.04	1.719	.56	1.01	1-3/8	.41
16-16R FBZ	16MSC16R	1610-1-16RS	1	1	2.35	1.04	1.88	.72	1.52	1-5/8	.88

**NOTE:** A and C dimensions are typical finger-tight. Dimensions for reference only, subject to change.  
Sealing washer must be used with BSPP end shown ISO228/1 (Form A). [see p.72](#)  
For Form B undercut change part number and add B before R. e.g. M6MSC1/4BR.

## FBZ, MSCR BSPP Male Connector For metric tube

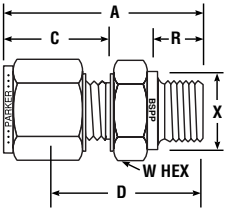
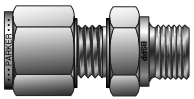

CPI™ PART NO.	A-LOK® PART NO.	INTER- CHANGES WITH	MILLIMETERS								
			TUBE O.D.	BSPP THREAD	A	C	D	R	X	W HEX	
FBZ 2-1/8R	M2MSC1/8R	2MO-1-2RS	2	1/8	28,4	15,3	21,8	7,1	14,0	13,7	
FBZ 3-1/8R	M3MSC1/8R	3MO-1-2RS	3	1/8	30,0	15,3	23,4	7,1	13,7	14,0	
FBZ 3-1/4R	M3MSC1/4R	3MO-1-4RS	3	1/4	35,3	15,3	28,7	11,2	17,8	19,0	
FBZ 6-1/8R	M6MSC1/8R	6MO-1-2RS	6	1/8	32,5	17,7	25,0	7,1	13,7	14,0	
FBZ 6-1/4R	M6MSC1/4R	6MO-1-4RS	6	1/4	37,7	17,7	30,2	11,2	17,8	19,0	
FBZ 6-3/8R	M6MSC3/8R	6MO-1-6RS	6	3/8	39,0	17,7	31,5	11,2	21,8	22,0	
FBZ 6-1/2R	M6MSC1/2R	6MO-1-8RS	6	1/2	45,6	17,7	38,1	14,2	25,7	27,0	
FBZ 8-1/8R	M8MSC1/8R	8MO-1-2RS	8	1/8	33,1	18,6	25,6	7,1	15,0	13,7	
FBZ 8-1/4R	M8MSC1/4R	8MO-1-4RS	8	1/4	38,5	18,6	31,0	11,2	17,8	19,0	
FBZ 8-3/8R	M8MSC3/8R	8MO-1-6RS	8	3/8	39,8	18,6	32,3	11,2	21,8	22,0	
FBZ 8-1/2R	M8MSC1/2R	8MO-1-8RS	8	1/2	45,6	18,6	38,1	14,2	25,7	27,0	
FBZ 10-1/4R	M10MSC1/4R	10MO-1-4RS	10	1/4	39,4	19,5	31,8	11,2	17,8	19,0	
FBZ 10-3/8R	M10MSC3/8R	10MO-1-6RS	10	3/8	40,6	19,5	33,0	11,2	21,8	22,0	
FBZ 10-1/2R	M10MSC1/2R	10MO-1-8RS	10	1/2	46,5	19,5	38,9	14,2	25,7	27,0	
FBZ 12-1/4R	M12MSC1/4R	12MO-1-4RS	12	1/4	42,6	22,0	32,5	11,2	17,8	22,0	
FBZ 12-3/8R	M12MSC3/8R	12MO-1-6RS	12	3/8	43,1	22,0	33,0	11,2	21,8	22,0	
FBZ 12-1/2R	M12MSC1/2R	12MO-1-8RS	12	1/2	49,0	22,0	38,9	14,2	25,7	27,0	
FBZ 12-3/4R	M12MSC3/4R	12MO-1-12RS	12	3/4	52,8	22,0	42,7	16,0	31,8	35,0	
FBZ 16-3/8R	M16MSC3/8R	16MO-1-6RS	16	3/8	43,5	22,0	33,4	11,2	22,0	21,8	
FBZ 16-1/2R	M16MSC1/2R	16MO-1-8RS	16	1/2	49,0	22,0	38,9	14,2	26,0	27,0	
FBZ 18-1/2R	M18MSC1/2R	18MO-1-8RS	18	1/2	49,0	22,0	38,9	14,2	26,0	27,0	
FBZ 18-3/4R	M18MSC3/4R	18MO-1-12RS	18	3/4	53,1	22,0	43,0	16,0	35,0	32,0	
FBZ 20-1/2R	M20MSC1/2R	20MO-1-8RS	20	1/2	50,5	22,0	40,4	14,2	30,0	25,7	
FBZ 20-3/4R	M20MSC3/4R	20MO-1-12RS	20	3/4	52,8	22,0	42,7	16,0	32,0	35,0	
FBZ 22-3/4R	M22MSC3/4R	22MO-1-12RS	22	3/4	52,8	22,0	42,7	16,0	32,0	35,0	
FBZ 25-3/4R	M25MSC3/4R	25MO-1-12RS	25	3/4	59,8	26,5	47,6	16,0	35,0	31,8	
FBZ 25-1R	M25MSC1R	25MO-1-16RS	25	1	60,1	26,5	47,8	18,3	39,0	41,0	

**NOTE:** A and C dimensions are typical finger-tight. Dimensions for reference only, subject to change.  
Sealing washer must be used with BSPP end shown ISO228/1 (Form A). [see p.72](#)  
For Form B undercut, add a "B" before the "R." e.g. M6MSC1/4BR.

## FBZ, MSCR BSPP Male Connector with ED seal For fractional tube

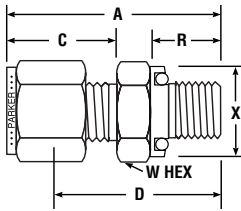
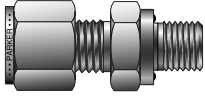

CPI™ PART NO.	A-LOK® PART NO.	INTER- CHANGES WITH	INCHES								
			TUBE O. D.	BSPP THREAD	A	C	D	R	X	W HEX	BORE
4-4R-ED FBZ	4MSC4R-ED	–	1/4	1/4	1.48	.70	1.19	.47	.74	3/4	.19
4-8R-ED FBZ	4MSC8R-ED	–	1/4	1/2	1.76	.70	1.38	.55	1.04	1-1/16	.19
6-6R-ED FBZ	6MSC6R-ED	–	3/8	3/8	1.60	.76	1.31	.47	.86	7/8	.28
8-4R-ED FBZ	8MSC4R-ED	–	1/2	1/4	1.69	.86	1.31	.47	.74	13/16	.25
8-6R-ED FBZ	8MSC6R-ED	–	1/2	3/8	1.69	.86	1.31	.47	.86	7/8	.31
8-8R-ED FBZ	8MSC8R-ED	–	1/2	1/2	1.85	.86	1.47	.55	1.04	1-1/16	.41
12-12R-ED FBZ	12MSC12R-ED	–	3/4	3/4	1.98	.86	1.59	.63	1.25	1-5/16	.63

**NOTE:** A and C dimensions are typical finger-tight. Dimensions for reference only, subject to change. ED fittings are supplied with sealing washers in nitrile as standard, suitable for temperatures of between –35°C and +100°C (–31°F to +212°F). Fluorocarbon seals are available upon request which are suitable for temperatures of between –25°C and +120°C (–13°F to +248°F).

## FBZ, MSCR Male Connector with ED seal For metric tube

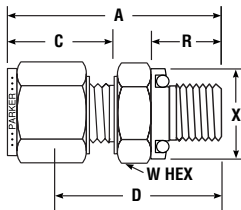
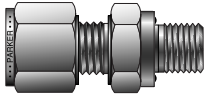

CPI™ PART NO.	A-LOK® PART NO.	INTER- CHANGES WITH	MILLIMETERS							
			TUBE O. D.	BSPP THREAD	A	C	D	R	X	W HEX
FBZ6-1/8R-ED	M6MSC1/8R-ED	–	6	1/8	32,5	17,7	25,0	7,9	13,7	14,0
FBZ6-1/4R-ED	M6MSC1/4R-ED	–	6	1/4	38,2	17,7	30,7	11,9	18,8	19,0
FBZ6-3/8R-ED	M6MSC3/8R-ED	–	6	3/8	39,5	17,7	32,0	11,9	21,8	22,0
FBZ6-1/2R-ED	M6MSC1/2R-ED	–	6	1/2	44,5	17,7	37,0	14,0	26,4	27,0
FBZ10-1/4R-ED	M10MSC1/4R-ED	–	10	1/4	40,0	19,5	32,3	11,9	18,8	19,0
FBZ10-3/8R-ED	M10MSC3/8R-ED	–	10	3/8	41,1	19,5	38,1	11,9	21,8	22,0
FBZ10-1/2R-ED	M10MSC1/2R-ED	–	10	1/2	46,0	19,5	38,4	14,0	26,4	27,0
FBZ12-1/4R-ED	M12MSC1/4R-ED	–	12	1/4	43,1	22,0	33,0	11,9	18,8	22,0
FBZ12-3/8R-ED	M12MSC3/8R-ED	–	12	3/8	43,6	22,0	33,5	11,9	21,8	22,0
FBZ12-1/2R-ED	M12MSC1/2R-ED	–	12	1/2	48,5	22,0	38,4	14,0	26,4	27,0

**NOTE:** A and C dimensions are typical finger-tight. Dimensions for reference only, subject to change. ED fittings are supplied with sealing washers in nitrile as standard, suitable for temperatures of between –35°C and +100°C (–31°F to +212°F). Fluorocarbon seals are available upon request which are suitable for temperatures of between –25°C and +120°C (–13°F to +248°F).

## Color Coding

For easy reference, table heads are color indicated as follows:

### fractional



### metric



## FH2BZ, MBCN NPT Male Bulkhead Connector

*For fractional tube*

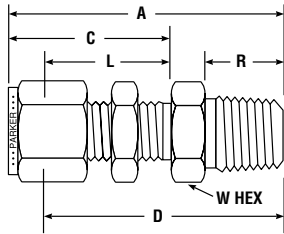
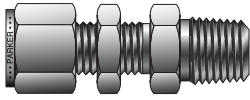

CPI™ PART NO.	A-LOK® PART NO.	INTER- CHANGES WITH	INCHES							
			TUBE O.D.	NPT PIPE THREAD	A	C	D	L	R	W HEX
1-1 FH2BZ	1MBC1N	100-11-1	1/16	1/16	1.19	.68	1.038	.53	.38	5/16
1-2 FH2BZ	1MBC2N	100-11-2	1/16	1/8	1.27	.68	1.116	.53	.38	7/16
2-2 FH2BZ	2MBC2N	200-11-2	1/8	1/8	1.83	1.23	1.571	.97	.38	1/2
3-2 FH2BZ	3MBC2N	300-11-2	3/16	1/8	1.89	1.26	1.634	1.00	.38	9/16
4-2 FH2BZ	4MBC2N	400-11-2	1/4	1/8	1.95	1.31	1.655	1.02	.38	5/8
4-4 FH2BZ	4MBC4N	400-11-4	1/4	1/4	2.132	1.31	1.842	1.02	.56	5/8
4-6 FH2BZ	4MBC6N	400-11-6	1/4	3/8	2.162	1.31	1.872	1.02	.56	11/16
4-8 FH2BZ	4MBC8N	400-11-8	1/4	1/2	2.374	1.31	2.084	1.02	.75	7/8
5-2 FH2BZ	5MBC2N	500-11-2	5/16	1/8	2.08	1.42	1.779	1.12	.38	11/16
5-4 FH2BZ	5MBC4N	500-11-4	5/16	1/4	2.27	1.42	1.966	1.12	.56	11/16
6-2 FH2BZ	6MBC2N	600-11-2	3/8	1/8	2.08	1.44	1.788	1.15	.38	3/4
6-4 FH2BZ	6MBC4N	600-11-4	3/8	1/4	2.265	1.44	1.975	1.15	.56	3/4
6-6 FH2BZ	6MBC6N	600-11-6	3/8	3/8	2.265	1.44	1.975	1.15	.56	3/4
6-8 FH2BZ	6MBC8N	600-11-8	3/8	1/2	2.48	1.44	2.219	1.15	.75	7/8
8-4 FH2BZ	8MBC4N	810-11-4	1/2	1/4	2.494	1.65	2.094	1.25	.56	15/16
8-6 FH2BZ	8MBC6N	810-11-6	1/2	3/8	2.494	1.65	2.094	1.25	.56	15/16
8-8 FH2BZ	8MBC8N	810-11-8	1/2	1/2	2.712	1.65	2.312	1.25	.75	15/16
8-12 FH2BZ	8MBC12N	810-11-12	1/2	3/4	2.722	1.65	2.322	1.25	.75	1-1/8
10-6 FH2BZ	10MBC6N	1010-11-6	5/8	3/8	2.628	1.68	2.228	1.28	.56	1-1/16
10-8 FH2BZ	10MBC8N	1010-11-8	5/8	1/2	2.816	1.68	2.416	1.28	.75	1-1/16
12-8 FH2BZ	12MBC8N	1210-11-8	3/4	1/2	3.00	1.87	2.601	1.47	.75	1-3/16
12-12 FH2BZ	12MBC12N	1210-11-12	3/4	3/4	3.00	1.87	2.601	1.47	.75	1-3/16
14-12 FH2BZ	14MBC12N	1410-11-12	7/8	3/4	3.31	2.09	2.913	1.69	.75	1-3/8
16-12 FH2BZ	16MBC12N	1610-11-12	1	3/4	3.54	2.27	3.006	1.78	.75	1-5/8
16-16 FH2BZ	16MBC16N	1610-11-16	1	1	3.72	2.27	3.194	1.78	.94	1-5/8

NOTE: A and C dimensions are typical finger-tight. Dimensions for reference only, subject to change. For bulkhead hole drill size and maximum bulkhead thickness, see Page 28, Part BC.

## FH2BZ, MBCN NPT Male Bulkhead Connector

*For metric tube*

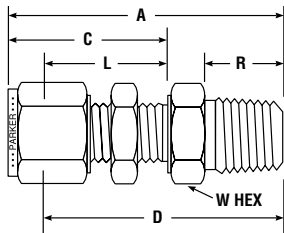
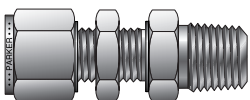

CPI™ PART NO.	A-LOK® PART NO.	INTER- CHANGES WITH	MILLIMETERS									
			TUBE O.D.	NPT THREAD	A	C	D	L	R	W HEX	B'HEAD HOLE DRILL SIZE	MAX. B'HEAD THICK.
FH2BZ 6-1/8	M6MBC1/8N	6MO-11-2	6	1/8	49,6	33,7	42,1	26,2	9,5	16,0	11,5	10,2
FH2BZ 6-1/4	M6MBC1/4N	6MO-11-4	6	1/4	53,5	33,7	46,0	26,2	14,3	16,0	11,5	10,2
FH2BZ 8-1/8	M8MBC1/8N	8MO-11-2	8	1/8	52,3	36,0	44,8	28,5	9,5	18,0	13,1	11,2
FH2BZ 8-1/4	M8MBC1/4N	8MO-11-4	8	1/4	57,5	36,0	50,0	28,5	14,3	18,0	13,1	11,2
FH2BZ 10-1/4	M10MBC1/4N	10MO-11-4	10	1/4	58,4	37,0	50,8	29,4	14,3	22,0	16,3	11,2
FH2BZ 10-3/8	M10MBC3/8N	10MO-11-6	10	3/8	58,4	37,0	50,8	29,4	14,3	22,0	16,3	11,2
FH2BZ 10-1/2	M10MBC1/2N	10MO-11-8	10	1/2	63,1	37,0	55,5	29,4	19,0	22,0	16,3	11,2
FH2BZ 12-1/4	M12MBC1/4N	12MO-11-4	12	1/4	63,3	40,1	53,2	31,8	14,3	24,0	19,5	12,7
FH2BZ 12-3/8	M12MBC3/8N	12MO-11-6	12	3/8	64,5	40,1	54,4	31,8	14,3	24,0	19,5	12,7
FH2BZ 12-1/2	M12MBC1/2N	12MO-11-8	12	1/2	67,5	40,1	57,4	31,8	19,0	24,0	19,5	12,7

NOTE: A and C dimensions are typical finger-tight. Dimensions for reference only, subject to change.

## FH4BZ, MTCN Thermocouple Connector

For fractional tube

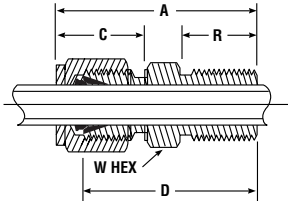
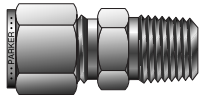

CPTM PART NO.	A-LOK® PART NO.	INTER-CHANGES WITH	INCHES						
			TUBE O.D.	NPT PIPE THREAD	A	C	D	R	W HEX
1-1 FH4BZ	1MTC1N	100-1-1BT	1/16	1/16	.93	.43	.78	.38	5/16
1-2 FH4BZ	1MTC2N	100-1-2BT	1/16	1/8	1.03	.43	.88	.38	7/16
1-4 FH4BZ	1MTC4N	100-1-4BT	1/16	1/4	1.23	.43	1.08	.56	9/16
2-1 FH4BZ	2MTC1N	200-1-1BT	1/8	1/16	1.17	.60	.91	.38	3/8
2-2 FH4BZ	2MTC2N	200-1-2BT	1/8	1/8	1.20	.60	.94	.38	7/16
2-4 FH4BZ	2MTC4N	200-1-4BT	1/8	1/4	1.40	.60	1.14	.56	9/16
3-2 FH4BZ	3MTC2N	300-1-2BT	3/16	1/8	1.23	.64	.97	.38	7/16
3-4 FH4BZ	3MTC4N	300-1-4BT	3/16	1/4	1.43	.64	1.17	.56	9/16
4-2 FH4BZ	4MTC2N	400-1-2BT	1/4	1/8	1.29	.70	1.00	.38	1/2
4-4 FH4BZ	4MTC4N	400-1-4BT	1/4	1/4	1.49	.70	1.20	.56	9/16
4-6 FH4BZ	4MTC6N	400-1-6BT	1/4	3/8	1.60	.70	1.22	.56	11/16
4-8 FH4BZ	4MTC8N	400-1-8BT	1/4	1/2	1.87	.70	1.47	.75	7/8
5-4 FH4BZ	5MTC4N	500-1-4BT	5/16	1/4	1.52	.73	1.22	.56	9/16
6-4 FH4BZ	6MTC4N	600-1-4BT	3/8	1/4	1.57	.76	1.28	.56	5/8
6-6 FH4BZ	6MTC6N	600-1-6BT	3/8	3/8	1.57	.76	1.28	.56	11/16
6-8 FH4BZ	6MTC8N	600-1-8BT	3/8	1/2	1.82	.76	1.53	.75	7/8
6-12 FH4BZ	6MTC12N	600-1-12BT	3/8	3/4	1.88	.76	1.59	.75	1-1/16
8-8 FH4BZ	8MTC8N	810-1-8BT	1/2	1/2	1.93	.87	1.53	.76	7/8
8-12 FH4BZ	8MTC12N	810-1-12BT	1/2	3/4	1.99	.87	1.59	.75	1-1/16
10-12 FH4BZ	10MTC12N	1010-1-12BT	5/8	3/4	1.99	.87	1.59	.75	1-1/16
12-12 FH4BZ	12MTC12N	1210-1-12BT	3/4	3/4	1.99	.87	1.59	.75	1-1/16
16-16 FH4BZ	16MTC16N	1610-1-16BT	1	1	2.46	1.05	1.97	.94	1-3/8

NOTE: A and C dimensions are typical finger-tight.

Dimensions for reference only, subject to change.

## CBZ, MSELN NPT Male Elbow

For fractional tube

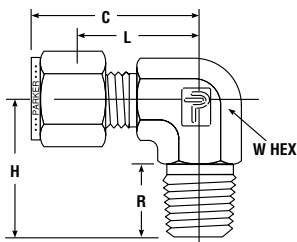
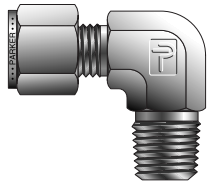

CPTM PART NO.	A-LOK® PART NO.	INTER-CHANGES WITH	INCHES						
			TUBE O.D.	NPT PIPE THREAD	C	H	L	R	W HEX
1-1 CBZ	1MSEL1N	100-2-1	1/16	1/16	.75	.70	.60	.38	7/16
1-2 CBZ	1MSEL2N	100-2-2	1/16	1/8	.75	.70	.60	.38	7/16
2-1 CBZ	2MSEL1N	200-2-1	1/8	1/16	.93	.70	.67	.38	7/16
2-2 CBZ	2MSEL2N	200-2-2	1/8	1/8	.93	.70	.67	.38	7/16
2-4 CBZ	2MSEL4N	200-2-4	1/8	1/4	.97	.93	.72	.56	9/16
3-2 CBZ	3MSEL2N	300-2-2	3/16	1/8	1.00	.74	.74	.38	1/2
3-4 CBZ	3MSEL4N	300-2-4	3/16	1/4	1.00	.93	.74	.56	9/16
4-1 CBZ	4MSEL1N	400-2-1	1/4	1/16	1.06	.74	.77	.38	1/2
4-2 CBZ	4MSEL2N	400-2-2	1/4	1/8	1.06	.74	.77	.38	1/2
4-4 CBZ	4MSEL4N	400-2-4	1/4	1/4	1.06	.93	.77	.56	9/16
4-6 CBZ	4MSEL6N	400-2-6	1/4	3/8	1.17	1.04	.88	.56	11/16
4-8 CBZ	4MSEL8N	400-2-8	1/4	1/2	1.25	1.31	.96	.75	13/16
5-2 CBZ	5MSEL2N	500-2-2	5/16	1/8	1.13	.79	.84	.38	9/16
5-4 CBZ	5MSEL4N	500-2-4	5/16	1/4	1.13	.97	.84	.56	9/16
6-2 CBZ	6MSEL2N	600-2-2	3/8	1/8	1.20	.82	.91	.38	5/8
6-4 CBZ	6MSEL4N	600-2-4	3/8	1/4	1.20	1.01	.91	.56	5/8
6-6 CBZ	6MSEL6N	600-2-6	3/8	3/8	1.23	1.13	.97	.56	11/16
6-8 CBZ	6MSEL8N	600-2-8	3/8	1/2	1.31	1.31	1.02	.75	13/16
6-12 CBZ	6MSEL12N	600-2-12	3/8	3/4	1.46	1.46	1.17	.75	1-1/16
8-4 CBZ	8MSEL4N	810-2-4	1/2	1/4	1.42	1.12	1.02	.56	13/16
8-6 CBZ	8MSEL6N	810-2-6	1/2	3/8	1.42	1.12	1.02	.56	13/16
8-8 CBZ	8MSEL8N	810-2-8	1/2	1/2	1.42	1.31	1.02	.75	13/16
8-12 CBZ	8MSEL12N	810-2-12	1/2	3/4	1.57	1.46	1.17	.75	1-1/16
10-6 CBZ	10MSEL6N	1010-2-6	5/8	3/8	1.50	1.20	1.10	.56	15/16
10-8 CBZ	10MSEL8N	1010-2-8	5/8	1/2	1.50	1.39	1.10	.75	15/16
10-12 CBZ	10MSEL12N	1010-2-12	5/8	3/4	1.57	1.46	1.17	.75	1-1/16
12-8 CBZ	12MSEL8N	1210-2-8	3/4	1/2	1.57	1.46	1.17	.75	1-1/16
12-12 CBZ	12MSEL12N	1210-2-12	3/4	3/4	1.57	1.46	1.17	.75	1-1/16
14-12 CBZ	14MSEL12N	1410-2-12	7/8	3/4	1.76	1.65	1.36	.75	1-3/8
16-12 CBZ	16MSEL12N	1610-2-12	1	3/4	1.93	1.65	1.45	.75	1-3/8
16-16 CBZ	16MSEL16N	1610-2-16	1	1	1.93	1.84	1.45	.94	1-3/8
20-20 CBZ	20MSEL20N	2010-2-20	1-1/4	1-1/4	2.61	1.88	1.75	.97	1-5/8
24-24 CBZ	24MSEL24N	2410-2-24	1-1/2	1-1/2	3.06	2.38	2.00	1.00	1-7/8
32-32 CBZ	32MSEL32N	3200-2-32	2	2	4.22	2.79	2.75	1.04	2-13/16

NOTE: C dimension is typical finger-tight.

Dimensions for reference only, subject to change.

Sizes 20, 24 require additional lubrication prior to assembly.

## Color Coding

For easy reference, table heads are color indicated as follows:

fractional



metric



## CBZ, MSELN NPT Male Metric Elbow For metric tube

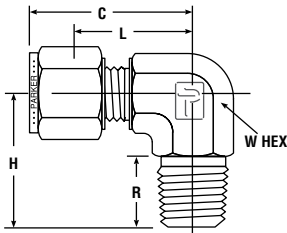
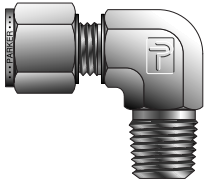

CPI™ PART NO.	A-LOK® PART NO.	INTER- CHANGES WITH	MILLIMETERS						INCH
			TUBE O.D.	NPT THREAD	C	H	L	R	W HEX
CBZ 3-1/8	M3MSEL1/8N	3MO-2-2	3	1/8	23,6	17,8	17,0	9,7	7/16
CBZ 3-1/4	M3MSEL1/4N	3MO-2-4	3	1/4	24,6	23,4	18,0	14,2	1/2
CBZ 4-1/8	M4MSEL1/8N	4MO-2-2	4	1/8	25,4	18,8	19,2	9,7	1/2
CBZ 4-1/4	M4MSEL1/4N	4MO-2-4	4	1/4	26,2	25,4	19,6	14,2	1/2
CBZ 6-1/8	M6MSEL1/8N	6MO-2-2	6	1/8	27,0	18,8	19,6	9,7	1/2
CBZ 6-1/4	M6MSEL1/4N	6MO-2-4	6	1/4	27,0	23,4	19,6	14,2	1/2
CBZ 6-3/8	M6MSEL3/8N	6MO-2-6	6	3/8	29,8	26,2	22,4	14,2	11/16
CBZ 6-1/2	M6MSEL1/2N	6MO-2-8	6	1/2	31,8	33,0	24,4	19,0	13/16
CBZ 8-1/8	M8MSEL1/8N	8MO-2-2	8	1/8	28,8	19,8	21,3	9,7	9/16
CBZ 8-1/4	M8MSEL1/4N	8MO-2-4	8	1/4	28,8	24,4	21,3	14,2	9/16
CBZ 8-3/8	M8MSEL3/8N	8MO-2-6	8	3/8	30,6	26,2	23,1	14,2	11/16
CBZ 8-1/2	M8MSEL1/2N	8MO-2-8	8	1/2	32,7	33,0	25,2	19,1	13/16
CBZ 10-1/8	M10MSEL1/8N	10MO-2-8	10	1/8	31,5	21,6	23,9	9,7	11/16
CBZ 10-1/4	M10MSEL1/4N	10MO-2-4	10	1/4	31,5	26,2	23,9	14,2	11/16
CBZ 10-3/8	M10MSEL3/8N	10MO-2-6	10	3/8	31,5	26,2	23,9	14,2	11/16
CBZ 10-1/2	M10MSEL1/2N	10MO-2-8	10	1/2	33,5	33,0	25,9	19,0	13/16
CBZ 12-1/4	M12MSEL1/4N	12MO-2-4	12	1/4	36,0	28,2	25,9	14,2	13/16
CBZ 12-3/8	M12MSEL3/8N	12MO-2-6	12	3/8	36,0	28,2	25,9	14,2	13/16
CBZ 12-1/2	M12MSEL1/2N	12MO-2-8	12	1/2	36,0	33,0	25,9	19,0	13/16
CBZ 12-3/4	M12MSEL3/4N	12MO-2-12	12	3/4	39,8	36,8	29,7	19,0	1-1/16
CBZ 15-1/2	M15MSEL1/2N	15MO-2-8	15	1/2	38,0	35,1	27,9	19,0	15/16
CBZ 16-3/8	M16MSEL3/8N	16MO-2-6	16	3/8	38,0	30,2	27,9	14,2	15/16
CBZ 16-1/2	M16MSEL1/2N	16MO-2-8	16	1/2	38,0	35,1	27,9	19,0	15/16
CBZ 16-3/4	M16MSEL3/4N	16MO-2-12	16	3/4	39,8	36,8	29,7	19,0	1-1/16
CBZ 18-1/2	M18MSEL1/2N	18MO-2-8	18	1/2	39,8	36,8	29,7	19,0	1-1/16
CBZ 18-3/4	M18MSEL3/4N	18MO-2-12	18	3/4	39,8	36,8	29,7	19,0	1-1/16
CBZ 20-1/2	M20MSEL1/2N	20MO-2-8	20	1/2	44,6	41,7	34,5	19,0	1-3/8
CBZ 20-3/4	M20MSEL3/4N	20MO-2-12	20	3/4	44,6	41,7	34,5	19,0	1-3/8
CBZ 22-3/4	M22MSEL3/4N	22MO-2-12	22	3/4	44,6	41,7	34,5	19,0	1-3/8
CBZ 25-3/4	M25MSEL3/4N	25MO-2-12	25	3/4	49,1	41,7	36,8	19,0	1-3/8
CBZ 25-1	M25MSEL1N	25MO-2-16	25	1	49,1	46,5	36,8	23,9	1-3/8

NOTE: C dimension is typical finger-tight.

Dimensions for reference only, subject to change.

## CBZ, MSELK BSP Taper Male Elbow For fractional tube

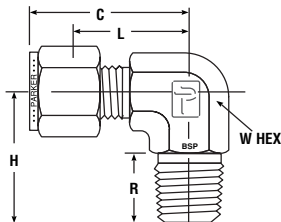
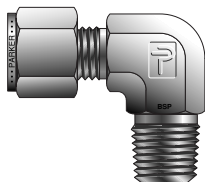

CPI™ PART NO.	A-LOK® PART NO.	INTER- CHANGES WITH	INCHES						
			TUBE O.D.	BSPT THREAD	C	H	L	R	W HEX
4-2K CBZ	4MSEL2K	400-2-2RT	1/4	1/8	1.06	.75	.77	.38	1/2
4-4K CBZ	4MSEL4K	400-2-4RT	1/4	1/4	1.06	.94	.77	.56	9/16
4-6K CBZ	4MSEL6K	400-2-6RT	1/4	3/8	1.17	1.05	.88	.56	11/16
4-8K CBZ	4MSEL8K	400-2-8RT	1/4	1/2	1.25	1.32	.96	.75	13/16
5-4K CBZ	5MSEL4K	500-2-4RT	5/16	1/4	1.13	.98	.84	.38	9/16
6-4K CBZ	6MSEL4K	600-2-4RT	3/8	1/4	1.20	1.02	.91	.56	5/8
6-6K CBZ	6MSEL6K	600-2-4RT	3/8	3/8	1.23	1.05	.97	.56	11/16
8-6K CBZ	8MSEL6K	810-2-6RT	1/2	3/8	1.42	1.13	1.02	.56	13/16
8-8K CBZ	8MSEL8K	810-2-8RT	1/2	1/2	1.42	1.32	1.02	.75	13/16

NOTE: C dimension is typical finger-tight.

Dimensions for reference only, subject to change.

## CBZ, MSELK BSP Taper Male Elbow

For metric tube

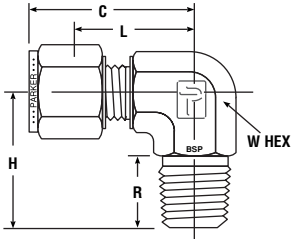
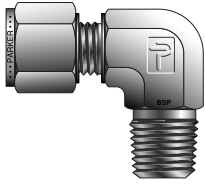

CPTM PART NO.	A-LOK® PART NO.	INTER- CHANGES WITH	MILLIMETERS						INCH W HEX
			TUBE O.D.	BSPT THREAD	C	H	L	R	
CBZ 3-1/8	M3MSEL1/8K	3MO-2-2RT	3	1/8	23,6	17,8	17,0	9,7	7/16
CBZ 3-1/4	M3MSEL1/4K	3MO-2-4RT	3	1/4	24,6	23,4	18,0	14,2	1/2
CBZ 4-1/8	M4MSEL1/8K	4MO-2-2RT	4	1/8	25,4	18,8	18,8	9,7	1/2
CBZ 4-1/4	M4MSEL1/4K	4MO-2-4RT	4	1/4	24,6	23,4	18,8	14,2	1/2
CBZ 6-1/8	M6MSEL1/8K	6MO-2-2RT	6	1/8	27,0	18,8	19,6	9,7	1/2
CBZ 6-1/4	M6MSEL1/4K	6MO-2-4RT	6	1/4	27,0	23,4	19,6	14,2	1/2
CBZ 6-3/8	M6MSEL3/8K	6MO-2-6RT	6	3/8	29,8	26,2	22,4	14,2	11/16
CBZ 6-1/2	M6MSEL1/2K	6MO-2-8RT	6	1/2	31,8	33,0	24,4	19,0	13/16
CBZ 8-1/8	M8MSEL1/8K	8MO-2-2RT	8	1/8	28,8	19,8	21,3	9,7	9/16
CBZ 8-1/4	M8MSEL1/4K	8MO-2-4RT	8	1/4	28,8	24,4	21,3	14,2	9/16
CBZ 8-3/8	M8MSEL3/8K	8MO-2-6RT	8	3/8	30,6	26,2	23,1	14,2	11/16
CBZ 8-1/2	M8MSEL1/2K	8MO-2-8RT	8	1/2	32,7	33,0	25,2	19,1	13/16
CBZ 10-1/8	M10MSEL1/8K	10MO-2-2RT	10	1/8	31,5	21,6	23,9	9,7	11/16
CBZ 10-1/4	M10MSEL1/4K	10MO-2-4RT	10	1/4	31,5	26,2	23,9	14,2	11/16
CBZ 10-3/8	M10MSEL3/8K	10MO-2-6RT	10	3/8	31,5	26,2	23,9	14,2	11/16
CBZ 10-1/2	M10MSEL1/2K	10MO-2-8RT	10	1/2	33,5	33,0	25,9	19,0	13/16
CBZ 12-1/4	M12MSEL1/4K	12MO-2-4RT	12	1/4	36,0	28,2	25,9	14,2	13/16
CBZ 12-3/8	M12MSEL3/8K	12MO-2-6RT	12	3/8	36,0	28,2	25,9	14,2	13/16
CBZ 12-1/2	M12MSEL1/2K	12MO-2-8RT	12	1/2	36,0	33,0	25,9	19,0	13/16
CBZ 12-3/4	M12MSEL3/4K	12MO-2-12RT	12	3/4	39,8	36,8	29,7	19,1	1-1/16
CBZ 16-3/8	M16MSEL3/8K	16MO-2-6RT	16	3/8	38,0	30,2	27,9	14,2	15/16
CBZ 16-1/2	M16MSEL1/2K	16MO-2-8RT	16	1/2	38,0	35,1	27,9	19,0	15/16
CBZ 18-1/2	M18MSEL1/2K	18MO-2-8RT	18	1/2	39,8	36,8	29,7	19,0	1-1/16
CBZ 18-3/4	M18MSEL3/4K	18MO-2-12RT	18	3/4	39,8	36,8	29,7	19,0	1-1/16
CBZ 20-3/4	M20MSEL3/4K	20MO-2-12RT	20	3/4	44,6	41,7	34,5	19,0	1-3/8
CBZ 25-3/4	M25MSEL3/4K	25MO-2-12RT	25	3/4	49,0	41,7	36,8	19,1	1-3/8
CBZ 25-1	M25MSEL1K	25MO-2-16RT	25	1	49,1	46,5	36,8	23,9	1-3/8

NOTE: C dimension is typical finger-tight.

Dimensions for reference only, subject to change.

## Color Coding

For easy reference, table heads are color indicated as follows:

**fractional**



**metric**





## VBZ, MVELN NPT Male 45° Elbow For fractional tube

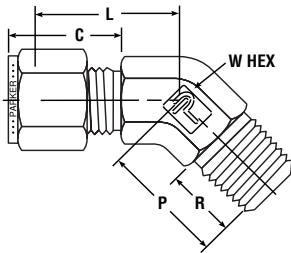
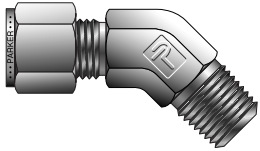

CPI™ PART NO.	A-LOK® PART NO.	INTER- CHANGES WITH	INCHES						
			TUBE O.D.	NPT PIPE THREAD	C	L	P	R	W HEX
1-1 VBZ	1MVEL1N	100-5-1	1/16	1/16	.43	.47	.57	.38	7/16
2-2 VBZ	2MVEL2N	200-5-2	1/8	1/8	.60	.53	.57	.38	7/16
3-2 VBZ	3MVEL2N	300-5-2	3/16	1/8	.64	.56	.58	.38	7/16
4-2 VBZ	4MVEL2N	400-5-2	1/4	1/8	.70	.66	.66	.38	9/16
4-4 VBZ	4MVEL4N	400-5-4	1/4	1/4	.70	.66	.86	.56	9/16
5-2 VBZ	5MVEL2N	500-5-2	5/16	1/8	.73	.66	.66	.38	9/16
6-2 VBZ	6MVEL2N	600-5-2	3/8	1/8	.76	.72	.67	.38	9/16
6-4 VBZ	6MVEL4N	600-5-4	3/8	1/4	.76	.72	.86	.56	9/16
6-6 VBZ	6MVEL6N	600-5-6	3/8	3/8	.76	.75	.95	.56	3/4
8-6 VBZ	8MVEL6N	810-5-6	1/2	3/8	.87	.75	.95	.56	3/4
10-8 VBZ	10MVEL8N	1010-5-8	5/8	1/2	.87	.84	1.20	.75	1-1/16
12-12 VBZ	12MVEL12N	1210-5-8	3/4	3/4	.87	.84	1.20	.75	1-1/16
14-12 VBZ	14MVEL12N	1410-5-8	7/8	3/4	.87	1.36	1.27	.75	1-5/16
16-16 VBZ	16MVEL16N	1610-5-8	1	1	1.05	1.19	1.14	.94	1-5/16

NOTE: C dimension is typical finger-tight.

Dimensions for reference only, subject to change.

## VBZ, MVELN NPT Male 45° Elbow For metric tube

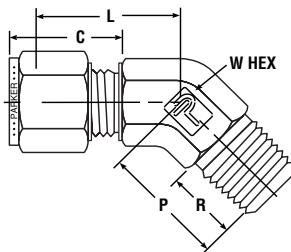
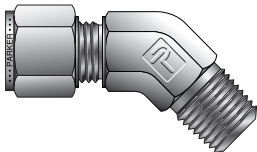

CPI™ PART NO.	A-LOK® PART NO.	INTER- CHANGES WITH	MILLIMETERS						
			TUBE O.D.	NPT PIPE THREAD	C	L	P	R	W HEX
VBZ 6-1/8	M6MVEL1/8N	—	6	1/8	17,7	16,0	16,8	9,5	14,0
VBZ 6-1/4	M6MVEL1/4N	—	6	1/4	17,7	16,0	21,8	14,3	14,0
VBZ 8-1/8	M8MVEL1/8N	—	8	1/8	18,6	16,8	16,8	9,5	14,0
VBZ 10-1/4	M10MVEL1/4N	—	10	1/4	19,5	19,0	24,1	14,3	19,0
VBZ 12-3/8	M12MVEL3/8N	—	12	3/8	22,0	19,0	24,1	14,3	19,0
VBZ 12-1/2	M12MVEL1/2N	—	12	1/2	22,0	20,6	29,7	19,0	22,0
VBZ 16-1/2	M16MVEL1/2N	—	16	1/2	22,0	20,6	29,7	19,0	22,0

NOTE: C dimension is typical finger-tight.

Dimensions for reference only, subject to change.

## RBZ, MRTN NPT Male Run Tee For fractional tube

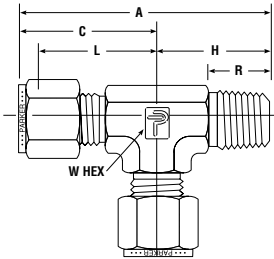
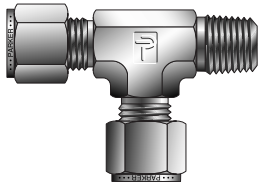

CPI™ PART NO.	A-LOK® PART NO.	INTER- CHANGES WITH	INCHES							
			TUBE O.D.	NPT PIPE THREAD	A	C	H	L	R	W HEX
2-2-2 RBZ	2MRT2N	200-3-2TMT	1/8	1/8	1.63	.93	.71	.66	.38	7/16
2-4-2 RBZ	2MRT4N	200-3-4TMT	1/8	1/4	1.89	.97	.93	.70	.56	9/16
3-2-3 RBZ	3MRT2N	300-3-2TMT	3/16	1/8	1.66	.96	.70	.70	.38	7/16
4-2-4 RBZ	4MRT2N	400-3-2TMT	1/4	1/8	1.80	1.06	.74	.77	.38	1/2
4-4-4 RBZ	4MRT4N	400-3-4TMT	1/4	1/4	1.98	1.06	.93	.77	.56	1/2
5-2-5 RBZ	5MRT2N	500-3-2TMT	5/16	1/8	1.99	1.17	.82	.88	.38	5/8
5-4-5 RBZ	5MRT4N	500-3-4TMT	5/16	1/4	2.18	1.17	1.01	.88	.56	5/8
6-4-6 RBZ	6MRT4N	600-3-4TMT	3/8	1/4	2.20	1.20	1.01	.91	.56	5/8
6-6-6 RBZ	6MRT6N	600-3-6TMT	3/8	3/8	2.42	1.31	1.12	1.02	.56	13/16
8-6-8 RBZ	8MRT6N	810-3-6TMT	1/2	3/8	2.53	1.42	1.12	1.02	.56	13/16
8-8-8 RBZ	8MRT8N	810-3-8TMT	1/2	1/2	2.72	1.42	1.31	1.02	.75	7/8
10-8-10 RBZ	10MRT8N	1010-3-8TMT	5/8	1/2	2.88	1.50	1.39	1.10	.75	15/16
12-12-12 RBZ	12MRT12N	1210-3-12TMT	3/4	3/4	3.02	1.57	1.46	1.17	.75	1-1/16
14-12-14 RBZ	14MRT12N	1410-3-12TMT	7/8	3/4	3.41	1.76	1.65	1.36	.75	1-3/8
16-12-16 RBZ	16MRT12N	1610-3-12TMT	1	3/4	3.59	1.94	1.65	1.45	.75	1-3/8
16-16-16 RBZ	16MRT16N	1610-3-16TMT	1	1	3.78	1.94	1.84	1.45	.94	1-3/8

NOTE: A and C dimensions are typical finger-tight.

Dimensions for reference only, subject to change.

## RBZ, MRTN NPT Male Run Tee For metric tube

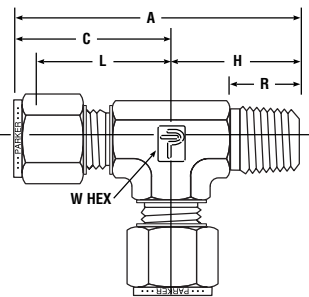
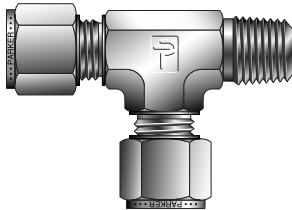

CPI™ PART NO.	A-LOK® PART NO.	INTER- CHANGES WITH	MILLIMETERS							INCH
			TUBE O.D.	NPT THREAD	A	C	H	L	R	W HEX
RBZ 6-1/8-6	M6MRT1/8N	6MO-3-2TMT	6	1/8	45,8	27,0	18,0	19,6	9,7	1/2
RBZ 6-1/4-6	M6MRT1/4N	6MO-3-4TMT	6	1/4	50,3	27,0	23,4	19,6	14,2	1/2
RBZ 8-1/8-8	M8MRT1/8N	8MO-3-2TMT	8	1/8	50,7	29,9	20,8	22,4	9,7	5/8
RBZ 8-1/4-8	M8MRT1/4N	8MO-3-4TMT	8	1/4	55,3	29,9	25,4	22,4	14,2	5/8
RBZ 10-1/4-10	M10MRT1/4N	10MO-3-4TMT	10	1/4	61,7	33,5	28,2	25,9	14,2	13/16
RBZ 10-1/2-10	M10MRT1/2N	10MO-3-8TMT	10	1/2	66,5	33,5	33,0	25,9	19,0	13/16
RBZ 12-1/4-12	M12MRT1/4N	12MO-3-4TMT	12	1/4	64,2	36,0	28,2	25,9	14,2	13/16
RBZ 12-3/8-12	M12MRT3/8N	12MO-3-6TMT	12	3/8	64,2	36,0	28,2	25,9	14,2	13/16
RBZ 12-1/2-12	M12MRT1/2N	12MO-3-8TMT	12	1/2	69,0	36,0	33,0	25,9	19,0	13/16
RBZ 16-1-16	M16MRT1N	16MO-3-16TMT	16	1	93,1	46,6	46,5	34,4	23,9	1-3/8

NOTE: A and C dimensions are typical finger-tight.

Dimensions for reference only, subject to change.

## Color Coding

For easy reference, table heads are color indicated as follows:

fractional



metric



## SBZ, MBTN NPT Male Branch Tee For fractional tube

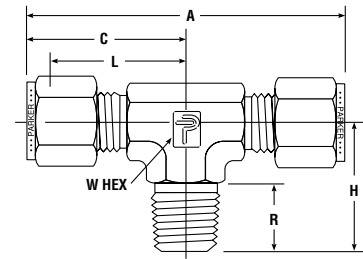
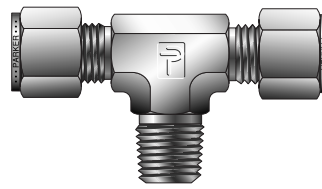

CPI™ PART NO.	A-LOK® PART NO.	INTER- CHANGES WITH	INCHES							
			TUBE O. D.	NPT PIPE THREAD	A	C	H	L	R	W HEX
2-2-2 SBZ	2MBT2N	200-3-2TTM	1/8	1/8	1.84	.92	.70	.66	.38	7/16
2-2-4 SBZ	2MBT4N	200-3-4TTM	1/8	1/4	1.96	.98	.93	.72	.56	1/2
3-3-2 SBZ	3MBT2N	300-3-2TTM	3/16	1/8	2.00	1.00	.74	.74	.38	1/2
4-4-2 SBZ	4MBT2N	400-3-2TTM	1/4	1/8	2.12	1.06	.74	.77	.38	1/2
4-4-4 SBZ	4MBT4N	400-3-4TTM	1/4	1/4	2.12	1.07	.93	.77	.56	1/2
5-5-2 SBZ	5MBT2N	500-3-2TTM	5/16	1/8	2.34	1.17	.82	.88	.38	5/8
5-5-4 SBZ	5MBT4N	500-3-4TTM	5/16	1/4	2.34	1.17	1.01	.88	.56	5/8
6-6-4 SBZ	6MBT4N	600-3-4TTM	3/8	1/4	2.40	1.20	1.01	.91	.56	5/8
6-6-6 SBZ	6MBT6N	600-3-6TTM	3/8	3/8	2.62	1.31	1.12	1.02	.56	13/16
8-8-6 SBZ	8MBT6N	810-3-6TTM	1/2	3/8	2.84	1.42	1.12	1.02	.56	13/16
8-8-8 SBZ	8MBT8N	810-3-8TTM	1/2	1/2	2.86	1.43	1.31	1.03	.75	7/8
10-10-8 SBZ	10MBT8N	1010-3-8TTM	5/8	1/2	2.86	1.53	1.42	1.13	.75	1
12-12-12 SBZ	12MBT12N	1210-3-12TTM	3/4	3/4	3.14	1.57	1.46	1.17	.75	1-1/16
14-14-12 SBZ	14MBT12N	1410-3-12TTM	7/8	3/4	3.52	1.76	1.65	1.36	.75	1-3/8
16-16-12 SBZ	16MBT12N	1610-3-12TTM	1	3/4	3.88	1.94	1.65	1.45	.75	1-3/8
16-16-16 SBZ	16MBT16N	1610-3-16TTM	1	1	3.88	1.94	1.84	1.45	.94	1-3/8

NOTE: A and C dimensions are typical finger-tight.

Dimensions for reference only, subject to change.

## SBZ, MBTN NPT Male Branch Tee For metric tube

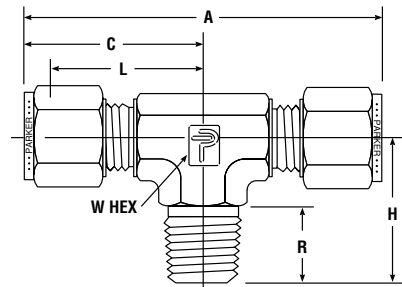
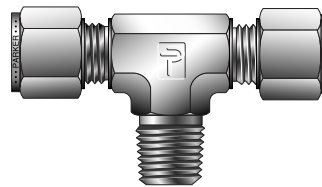

CPI™ PART NO.	A-LOK® PART NO.	INTER- CHANGES WITH	MILLIMETERS								INCH W HEX
			TUBE O. D.	NPT THREAD	A	C	H	L	R		
SBZ 6-6-1/8	M6MBT1/8N	6MO-3TTM	6	1/8	53,9	27,0	18,8	19,6	9,7	1/2	
SBZ 6-6-1/4	M6MBT1/4N	6MO-3-4TTM	6	1/4	53,9	27,0	23,4	19,6	14,2	1/2	
SBZ 8-8-1/8	M8MBT1/8N	8MO-3TTM	8	1/8	59,7	29,9	20,8	22,4	9,7	5/8	
SBZ 8-8-1/4	M8MBT1/4N	8MO-3-4TTM	8	1/4	59,7	29,9	25,4	22,4	14,2	5/8	
SBZ 10-10-1/4	M10MBT1/4N	10MO-3-4TTM	10	1/4	67,0	33,5	28,2	25,9	14,2	13/16	
SBZ 10-10-3/8	M10MBT3/8N	10MO-3-6TTM	10	3/8	67,0	33,5	28,2	25,9	14,2	13/16	
SBZ 12-12-1/4	M12MBT1/4N	12MO-3-4TTM	12	1/4	72,0	36,0	28,2	25,9	14,2	13/16	
SBZ 12-12-3/8	M12MBT3/8N	12MO-3-6TTM	12	3/8	72,0	36,0	28,2	25,9	14,2	13/16	
SBZ 12-12-1/2	M12MBT1/2N	12MO-3-8TTM	12	1/2	72,0	36,0	33,0	25,9	19,0	13/16	
SBZ 16-16-1/2	M16MBT1/2N	16MO-3-8TTM	16	1/2	77,6	38,8	35,8	28,7	19,1	1	

NOTE: A and C dimensions are typical finger-tight.

Dimensions for reference only, subject to change.

## GBZ, FSCN NPT Female Connector For fractional tube

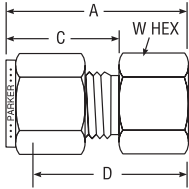
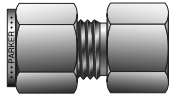

CPI™ PART NO.	A-LOK® PART NO.	INTER- CHANGES WITH	INCHES					
			TUBE O. D.	NPT PIPE THREAD	A	C	D	W HEX
1-1 GBZ	1FSC1N	100-7-1	1/16	1/16	.93	.43	.78	7/16
1-2 GBZ	1FSC2N	100-7-2	1/16	1/8	.95	.43	.81	9/16
2-2 GBZ	2FSC2N	200-7-2	1/8	1/8	1.14	.60	.88	9/16
2-4 GBZ	2FSC4N	200-7-4	1/8	1/4	1.32	.60	1.06	3/4
3-2 GBZ	3FSC2N	300-7-2	3/16	1/8	1.17	.64	.91	9/16
3-4 GBZ	3FSC4N	300-7-4	3/16	1/4	1.35	.64	1.09	3/4
4-2 GBZ	4FSC2N	400-7-2	1/4	1/8	1.23	.70	.94	9/16
4-4 GBZ	4FSC4N	400-7-4	1/4	1/4	1.42	.70	1.13	3/4
4-6 GBZ	4FSC6N	400-7-6	1/4	3/8	1.48	.70	1.19	7/8
4-8 GBZ	4FSC8N	400-7-8	1/4	1/2	1.67	.70	1.38	1-1/16
5-2 GBZ	5FSC2N	500-7-2	5/16	1/8	1.27	.73	.97	9/16
5-4 GBZ	5FSC4N	500-7-4	5/16	1/4	1.46	.73	1.16	3/4
5-6 GBZ	5FSC6N	500-7-6	5/16	3/8	1.48	.73	1.219	7/8
6-2 GBZ	6FSC2N	600-7-2	3/8	1/8	1.29	.76	1.00	5/8
6-4 GBZ	6FSC4N	600-7-4	3/8	1/4	1.48	.76	1.19	3/4
6-6 GBZ	6FSC6N	600-7-6	3/8	3/8	1.54	.76	1.25	7/8
6-8 GBZ	6FSC8N	600-7-8	3/8	1/2	1.73	.76	1.44	1-1/16
6-12 GBZ	6FSC12N	600-7-12	3/8	3/4	1.85	.76	1.56	1-1/4
8-4 GBZ	8FSC4N	810-7-4	1/2	1/4	1.59	.87	1.19	13/16
8-6 GBZ	8FSC6N	810-7-6	1/2	3/8	1.65	.87	1.25	7/8
8-8 GBZ	8FSC8N	810-7-8	1/2	1/2	1.84	.87	1.44	1-1/16
8-12 GBZ	8FSC12N	810-7-12	1/2	3/4	1.96	.87	1.56	1-1/4
10-6 GBZ	10FSC6N	1010-7-6	5/8	3/8	1.65	.87	1.25	15/16
10-8 GBZ	10FSC8N	1010-7-8	5/8	1/2	1.84	.87	1.44	1-1/16
10-12 GBZ	10FSC12N	1010-7-12	5/8	3/4	1.96	.87	1.56	1-3/8
12-8 GBZ	12FSC8N	1210-7-8	3/4	1/2	1.84	.87	1.44	1-1/16
12-12 GBZ	12FSC12N	1210-7-12	3/4	3/4	1.96	.87	1.56	1-3/8
14-12 GBZ	14FSC12N	1410-7-12	7/8	3/4	1.96	.87	1.56	1-3/8
16-12 GBZ	16FSC12N	1610-7-12	1	3/4	2.15	1.05	1.66	1-3/8
16-16 GBZ	16FSC16N	1610-7-16	1	1	2.46	1.05	1.97	1-5/8
20-20 GBZ	20FSC20N	2010-7-20	1-1/4	1-1/4	2.94	1.52	2.08	2
24-24 GBZ	24FSC24N	2410-7-24	1-1/2	1-1/2	3.28	1.77	2.22	2-3/8
32-32 GBZ	32FSC32N	3210-7-32	2	2	4.00	2.47	2.53	2-7/8

NOTE: A and C dimensions are typical finger-tight.

Dimensions for reference only, subject to change.

Sizes 20, 24, 32 require additional lubrication prior to assembly.

## GBZ, FSCN NPT Female Connector For metric tube

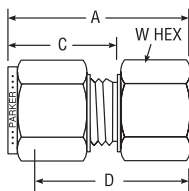
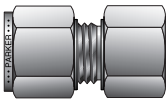

CPI™ PART NO.	A-LOK® PART NO.	INTER- CHANGES WITH	MILLIMETERS					
			TUBE O. D.	NPT THREAD	A	C	D	W HEX
GBZ 3-1/8	M3FSC1/8N	3MO-7-2	3	1/8	28,8	15,3	22,2	14,0
GBZ 3-1/4	M3FSC1/4N	3MO-7-4	3	1/4	33,6	15,3	27,0	19,0
GBZ 4-1/8	M4FSC1/8N	4MO-7-2	4	1/8	29,6	16,1	23,0	14,0
GBZ 6-1/8	M6FSC1/8N	6MO-7-2	6	1/8	31,3	17,7	23,8	14,0
GBZ 6-1/4	M6FSC1/4N	6MO-7-4	6	1/4	36,1	17,7	28,6	19,0
GBZ 6-3/8	M6FSC3/8N	6MO-7-6	6	3/8	37,7	17,7	30,2	22,0
GBZ 6-1/2	M6FSC1/2N	6MO-7-8	6	1/2	42,5	17,7	35,0	27,0
GBZ 8-1/8	M8FSC1/8N	8MO-7-2	8	1/8	32,1	18,6	24,6	14,0
GBZ 8-1/4	M8FSC1/4N	8MO-7-4	8	1/4	36,9	18,6	29,4	19,0
GBZ 8-3/8	M8FSC3/8N	8MO-7-6	8	3/8	38,5	18,6	31,0	22,0
GBZ 10-1/4	M10FSC1/4N	10MO-7-4	10	1/4	37,8	19,5	30,2	19,0
GBZ 10-3/8	M10FSC3/8N	10MO-7-6	10	3/8	39,4	19,5	31,8	22,0
GBZ 10-1/2	M10FSC1/2N	10MO-7-8	10	1/2	44,1	19,5	36,5	27,0
GBZ 12-1/4	M12FSC1/4N	12MO-7-4	12	1/4	41,9	22,0	31,8	22,0
GBZ 12-3/8	M12FSC3/8N	12MO-7-6	12	3/8	41,9	22,0	31,8	22,0
GBZ 12-1/2	M12FSC1/2N	12MO-7-8	12	1/2	46,6	22,0	36,5	27,0
GBZ 16-3/8	M16FSC3/8N	16MO-7-6	16	3/8	41,9	22,0	31,8	27,0
GBZ 16-1/2	M16FSC1/2N	16MO-7-8	16	1/2	46,9	22,0	36,5	27,0
GBZ 20-1/2	M20FSC1/2N	20MO-7-8	20	1/2	47,9	22,0	37,8	30,0
GBZ 20-3/4	M20FSC3/4N	20MO-7-12	20	3/4	49,7	22,0	39,6	35,0
GBZ 22-3/4	M22FSC3/4N	22MO-7-12	22	3/4	49,7	22,0	39,6	35,0
GBC 25-3/4	M25FSC3/4N	25MO-7-12	25	3/4	53,6	26,5	41,3	35,0
GBC 25-1	M25FSC1N	25MO-7-16	25	1	62,3	26,5	50,0	41,0

Dimensions for reference only, subject to change.

## GBZ, FSCK BSP Taper Female Connector *For fractional tube*

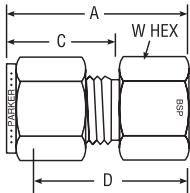
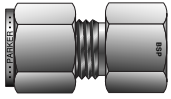

CPI™ PART NO.	A-LOK® PART NO.	INTER- CHANGES WITH	INCHES						
			TUBE O.D.	BSPT THREAD	A	C	D	W HEX	BORE
4-2K GBZ	4FSC2K	400-7-2RT	1/4	1/8	1.24	.70	.94	9/16	.19
4-4K GBZ	4FSC4K	400-7-4RT	1/4	1/4	1.42	.70	1.13	3/4	.19
4-6K GBZ	4FSC6K	400-7-6RT	1/4	3/8	1.49	.70	1.19	7/8	.19
4-8K GBZ	4FSC8K	400-7-8RT	1/4	1/2	1.68	.70	1.38	1-1/16	.19
6-4K GBZ	6FSC4K	600-7-4RT	3/8	1/4	1.48	.76	1.19	3/4	.28
6-6K GBZ	6FSC6K	600-7-6RT	3/8	3/8	1.54	.76	1.25	7/8	.28
6-8K GBZ	6FSC8K	600-7-8RT	3/8	1/2	1.73	.76	1.44	1-1/16	.28
8-4K GBZ	8FSC4K	810-7-4RT	1/2	1/4	1.59	.87	1.19	13/16	.406
8-6K GBZ	8FSC6K	810-7-6RT	1/2	3/8	1.65	.87	1.25	7/8	.406
8-8K GBZ	8FSC8K	810-7-8RT	1/2	1/2	1.84	.87	1.44	1-1/16	.406

Dimensions for reference only, subject to change.

## GBZ, FSCK BSP Taper Female Connector *For metric tube*

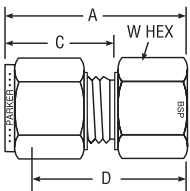
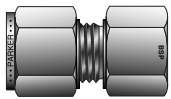

CPI™ PART NO.	A-LOK® PART NO.	INTER- CHANGES WITH	MILLIMETERS					
			TUBE O.D.	BSPT THREAD	A	C	D	W HEX
GBZ 3-1/8K	M3FSC1/8K	3MO-7-2RT	3	1/8	29,2	15,3	22,6	14,0
GBZ 6-1/8K	M6FSC1/8K	6MO-7-2RT	6	1/8	31,3	17,7	23,8	14,0
GBZ 6-1/4K	M6FSC1/4K	6MO-7-4RT	6	1/4	35,8	17,7	28,3	19,0
GBZ 6-3/8K	M6FSC3/8K	6MO-7-6RT	6	3/8	37,6	17,7	30,1	22,0
GBZ 6-1/2K	M6FSC1/2K	6MO-7-8RT	6	1/2	42,5	17,7	35,0	27,0
GBZ 8-1/8K	M8FSC1/8K	8MO-7-2RT	8	1/8	32,8	18,6	25,3	15,0
GBZ 8-1/4K	M8FSC1/4K	8MO-7-4RT	8	1/4	37,0	18,6	29,5	19,0
GBZ 8-3/8K	M8FSC3/8K	8MO-7-6RT	8	3/8	38,5	18,6	31,0	22,0
GBZ 8-1/2K	M8FSC1/2K	8MO-7-8RT	8	1/2	43,3	18,6	35,8	27,0
GBZ 10-1/8K	M10FSC1/8K	10MO-7-2RT	10	1/8	33,0	19,5	25,4	18,0
GBZ 10-1/4K	M10FSC1/4K	10MO-7-4RT	10	1/4	37,8	19,5	30,2	19,0
GBZ 10-3/8K	M10FSC3/8K	10MO-7-6RT	10	3/8	39,4	19,5	31,8	22,0
GBZ 10-1/2K	M10FSC1/2K	10MO-7-8RT	10	1/2	44,2	19,5	36,6	27,0
GBZ 12-1/4K	M12FSC1/4K	12MO-7-4RT	12	1/4	40,3	22,0	30,2	22,0
GBZ 12-3/8K	M12FSC3/8K	12MO-7-6RT	12	3/8	41,9	22,0	31,8	22,0
GBZ 12-1/2K	M12FSC1/2K	12MO-7-8RT	12	1/2	46,7	22,0	36,6	27,0
GBZ 16-1/2K	M16FSC1/2K	16MO-7-8RT	16	1/2	48,4	22,0	38,3	18,0
GBZ 20-1/2K	M20FSC1/2K	20MO-7-8RT	20	1/2	54,7	22,0	44,6	30,0
GBZ 20-3/4K	M20FSC3/4K	20MO-7-12RT	20	3/4	49,7	22,0	39,6	35,0
GBZ 22-1K	M22FSC1K	22MO-7-16RT	22	1	57,9	22,0	47,8	41,0
GBZ 25-3/4K	M25FSC3/4K	25MO-7-12RT	25	3/4	54,3	26,5	42,1	35,0
GBZ 25-1K	M25FSC1K	25MO-7-16RT	25	1	61,5	26,5	49,3	41,0

NOTE: A and C dimensions are typical finger-tight.

Dimensions for reference only, subject to change.

## Color Coding

For easy reference, table heads are color indicated as follows:

**fractional**



**metric**



## GH2BZ, FBCN NPT Female Bulkhead Connector

For fractional tube

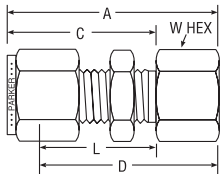
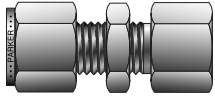

CPI™ PART NO.	A-LOK® PART NO.	INTER- CHANGES WITH	INCHES						
			TUBE O.D.	NPT PIPE THREAD	A	C	D	L	W HEX
2-2 GH2BZ	2FBC2N	200-71-2	1/8	1/8	1.76	1.23	1.50	.97	9/16
3-2 GH2BZ	3FBC2N	300-71-2	3/16	1/8	1.79	1.26	1.53	1.00	9/16
4-2 GH2BZ	4FBC2N	400-71-2	1/4	1/8	1.85	1.31	1.56	1.02	5/8
4-4 GH2BZ	4FBC4N	400-71-4	1/4	1/4	2.04	1.31	1.75	1.02	3/4
5-2 GH2BZ	5FBC2N	500-71-2	5/16	1/8	1.96	1.42	1.66	1.12	11/16
5-8 GH2BZ	5FBC8N	500-71-8	5/16	1/2	2.38	1.42	2.08	1.12	1-1/16
6-4 GH2BZ	6FBC4N	600-71-4	3/8	1/4	2.17	1.44	1.88	1.15	3/4
8-6 GH2BZ	8FBC6N	810-71-6	1/2	3/8	2.43	1.65	2.03	1.25	15/16
8-8 GH2BZ	8FBC8N	810-71-8	1/2	1/2	2.62	1.65	2.22	1.25	1-1/16
10-8 GH2BZ	10FBC8N	1010-71-8	5/8	1/2	2.65	1.68	2.25	1.28	1-1/16
12-12 GH2BZ	12FBC12N	1210-71-12	3/4	3/4	2.90	1.87	2.50	1.47	1-3/8
14-12 GH2BZ	14FBC12N	1410-71-12	7/8	3/4	3.18	2.09	2.78	1.69	1-3/8
16-16 GH2BZ	16FBC16N	1610-71-16	1	1	3.68	2.27	3.19	1.78	1-5/8

NOTE: A and C dimensions are typical finger-tight. Dimensions for reference only, subject to change.  
For bulkhead hole drill size and maximum bulkhead thickness, see Page 28, Part BC.

## GH2BZ, FBCN NPT Female Bulkhead Connector

For metric tube

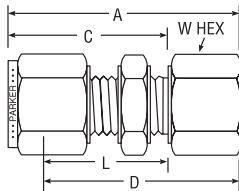
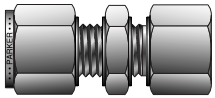

CPI™ PART NO.	A-LOK® PART NO.	INTER- CHANGES WITH	MILLIMETERS								
			TUBE O.D.	NPT THREAD	A	C	D	L	W HEX	B' HEAD HOLE DRILL SIZE	MAX. B' HEAD THICK.
GH2BZ 6-1/8	M6FBC1/8N	6MO-71-2	6	1/8	47,2	33,7	39,7	26,2	16,0	11,5	10,2
GH2BZ 6-1/4	M6FBC1/4N	6MO-71-4	6	1/4	52,0	33,7	44,5	26,2	19,0	11,5	10,2
GH2BZ 8-1/8	M8FBC1/8N	8MO-71-2	8	1/8	49,6	36,1	42,1	28,5	18,0	13,1	11,2
GH2BZ 10-1/4	M10FBC1/4N	10MO-71-4	10	1/4	55,2	37,0	47,6	29,4	19,0	16,3	11,2
GH2BZ 12-3/8	M12FBC3/8N	12MO-71-6	12	3/8	60,9	41,9	50,8	31,8	24,0	19,5	12,7
GH2BZ 12-1/2	M12FBC1/2N	12MO-71-8	12	1/2	66,4	41,9	56,3	31,8	27,0	19,5	12,7

NOTE: A and C dimensions are typical finger-tight. Dimensions for reference only, subject to change.  
For bulkhead hole drill size and maximum bulkhead thickness, see Page 28, Part BC.

## GBZ, FSC GC BSPP Gauge Connector

For fractional tube

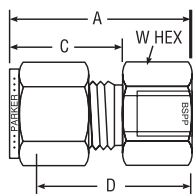
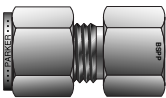

CPI™ PART NO.	A-LOK® PART NO.	INTER- CHANGES WITH	INCHES						
			TUBE O.D.	BSPP THREAD	A	C	D	W HEX	BORE
4-4GC GBZ	4FSC4GC	400-7-4RG	1/4	1/4	1.48	.70	1.19	3/4	.19
4-6GC GBZ	4FSC6GC	400-7-6RG	1/4	3/8	1.48	.70	1.19	7/8	.19
4-8GC GBZ	4FSC8GC	400-7-8RG	1/4	1/2	1.70	.70	1.41	1-1/16	.19
5-4GC GBZ	5FSC4GC	500-7-4RG	5/16	1/4	1.51	.73	1.22	3/4	.21
5-8GC GBZ	5FSC8GC	500-7-8RG	5/16	1/2	1.59	.73	1.30	1-1/16	.28
6-4GC GBZ	6FSC4GC	600-7-4RG	3/8	1/4	1.55	.76	1.25	3/4	.21
6-6GC GBZ	6FSC6GC	600-7-6RG	3/8	3/8	1.55	.76	1.25	7/8	.26
6-8GC GBZ	6FSC8GC	600-7-8RG	3/8	1/2	1.63	.76	1.33	1-1/16	.28
8-4GC GBZ	8FSC4GC	810-7-4RG	1/2	1/4	1.65	.86	1.25	13/16	.21
8-6GC GBZ	8FSC6GC	810-7-6RG	1/2	3/8	1.75	.86	1.35	7/8	.26
8-8GC GBZ	8FSC8GC	810-7-8RG	1/2	1/2	1.90	.86	1.50	1-1/16	.28

NOTE: A and C dimensions are typical finger-tight. Dimensions for reference only, subject to change.  
See Catalog 4260 Pipe/ISO Fittings for detailed information.  
Sealing Washer on page 72 to be used with this fitting.

## GBZ, GCR BSPP Gauge Connector For metric tube

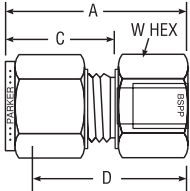
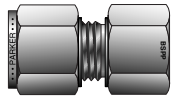

CPI™ PART NO.	A-LOK® PART NO.	INTER- CHANGES WITH	MILLIMETERS					
			TUBE O.D.	BSPP THREAD	A	C	D	W HEX
GBZ 3-1/4GC	M3GC1/4R	3MO-7-4RG	3	1/4	35,3	15,3	28,7	19,0
GBZ 6-1/4GC	M6GC1/4R	6MO-7-4RG	6	1/4	37,7	17,7	30,2	19,0
GBZ 6-3/8GC	M6GC3/8R	6MO-7-6RG	6	3/8	37,7	17,7	30,2	22,0
GBZ 6-1/2GC	M6GC1/2R	6MO-7-8RG	6	1/2	43,2	17,7	35,7	27,0
GBZ 8-1/4GC	M8GC1/4R	8MO-7-4RG	8	1/4	38,5	18,6	31,0	19,0
GBZ 8-3/8GC	M8GC3/8R	8MO-7-6RG	8	3/8	40,8	18,6	33,3	22,0
GBZ 8-1/2GC	M8GC1/2R	8MO-7-8RG	8	1/2	44,0	18,6	36,5	27,0
GBZ 10-1/4GC	M10GC1/4R	10MO-7-4RG	10	1/4	39,4	19,5	31,8	19,0
GBZ 10-3/8GC	M10GC3/8R	10MO-7-6RG	10	3/8	38,8	19,5	31,2	22,0
GBC 10-1/2GC	M10GC1/2R	10MO-7-8RG	10	1/2	41,3	19,5	33,7	27,0
GBC 12-1/4GC	M12GC1/4R	12MO-7-4RG	12	1/4	41,9	22,0	31,8	22,0
GBC 12-3/8GC	M12GC3/8R	12MO-7-6RG	12	3/8	44,4	22,0	34,3	22,0
GBC 12-1/2GC	M12GC1/2R	12MO-7-8RG	12	1/2	48,2	22,0	38,1	27,0

NOTE: A and C dimensions are typical finger-tight.  
See Catalog 4260 Pipe/ISO Fittings for detailed information.  
Sealing Washer on page 72 to be used with this fitting.

Dimensions for reference only, subject to change.

## DBZ, FELN NPT Female Elbow For fractional tube

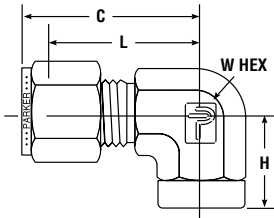
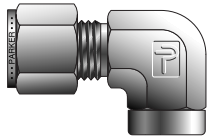

CPI™ PART NO.	A-LOK® PART NO.	INTER- CHANGES WITH	INCHES					
			TUBE O.D.	NPT PIPE THREAD	C	H	L	W HEX
1-1 DBZ	1FEL1N	100-8-1	1/16	1/16	.75	.50	.60	7/16
1-2 DBZ	1FEL2N	100-8-2	1/16	1/8	.79	.75	.64	9/16
2-2 DBZ	2FEL2N	200-8-2	1/8	1/8	.97	.75	.71	9/16
2-4 DBZ	2FEL4N	200-8-4	1/8	1/4	1.10	.88	.84	3/4
3-2 DBZ	3FEL2N	300-8-2	3/16	1/8	1.00	.75	.74	9/16
4-2 DBZ	4FEL2N	400-8-2	1/4	1/8	1.06	.75	.77	9/16
4-4 DBZ	4FEL4N	400-8-4	1/4	1/4	1.20	.88	.91	11/16
4-6 DBZ	4FEL6N	400-8-6	1/4	3/8	1.25	.88	.96	13/16
4-8 DBZ	4FEL8N	400-8-8	1/4	1/2	1.36	1.13	1.07	1
5-2 DBZ	5FEL2N	500-8-2	5/16	1/8	1.13	.75	.84	9/16
5-4 DBZ	5FEL4N	500-8-4	5/16	1/4	1.24	.88	.94	11/16
6-2 DBZ	6FEL2N	600-8-2	3/8	1/8	1.20	.75	.91	5/8
6-4 DBZ	6FEL4N	600-8-4	3/8	1/4	1.26	.88	.97	11/16
6-6 DBZ	6FEL6N	600-8-6	3/8	3/8	1.31	.88	1.02	13/16
6-8 DBZ	6FEL8N	600-8-8	3/8	1/2	1.42	1.13	1.13	1
8-4 DBZ	8FEL4N	810-8-4	1/2	1/4	1.42	.88	1.02	13/16
8-6 DBZ	8FEL6N	810-8-6	1/2	3/8	1.42	.88	1.02	13/16
8-8 DBZ	8FEL8N	810-8-8	1/2	1/2	1.53	1.13	1.13	1
10-6 DBZ	10FEL6N	1010-8-6	5/8	3/8	1.50	.88	1.10	15/16
10-8 DBZ	10FEL8N	1010-8-8	5/8	1/2	1.57	1.13	1.17	1-1/16
12-8 DBZ	12FEL8N	1210-8-8	3/4	1/2	1.57	1.13	1.17	1-1/16
12-12 DBZ	12FEL12N	1210-8-12	3/4	3/4	1.76	1.25	1.36	1-3/8
14-12 DBZ	14FEL12N	1410-8-12	7/8	3/4	1.76	1.25	1.36	1-3/8
16-12 DBZ	16FEL12N	1610-8-12	1	3/4	1.93	1.25	1.45	1-3/8
16-16 DBZ	16FEL16N	1610-8-16	1	1	2.02	1.50	1.53	1-5/8

NOTE: C dimension is typical finger-tight.

Dimensions for reference only, subject to change.

## DBZ, FELN NPT Female Elbow For metric tube

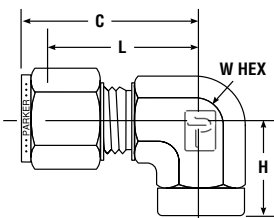

CPI™ PART NO.	A-LOK® PART NO.	INTER- CHANGES WITH	MILLIMETERS				INCH	
			TUBE O.D.	NPT THREAD	C	H	L	W HEX
DBZ 6-1/8	M6FEL1/8N	6MO-8-2	6	1/8	27,0	19,0	19,6	1/2
DBZ 6-1/4	M6FEL1/4N	6MO-8-4	6	1/4	29,8	22,4	22,4	11/16
DBZ 8-1/8	M8FEL1/8N	8MO-8-2	8	1/8	28,8	19,1	21,3	9/16
DBZ 8-1/4	M8FEL1/4N	8MO-8-4	8	1/4	30,6	22,4	23,1	11/16
DBZ 10-1/4	M10FEL1/4N	10MO-8-4	10	1/4	33,5	22,4	25,9	13/16
DBZ 10-3/8	M10FEL3/8N	10MO-8-6	10	3/8	33,5	22,4	25,9	13/16
DBZ 10-1/2	M10FEL1/2N	10MO-8-8	10	1/2	36,3	28,5	28,7	1
DBZ 12-1/4	M12FEL1/4N	12MO-8-4	12	1/4	36,0	22,4	25,9	13/16
DBZ 12-3/8	M12FEL3/8N	12MO-8-6	12	3/8	36,0	22,4	25,9	13/16
DBZ 12-1/2	M12FEL1/2N	12MO-8-8	12	1/2	38,8	28,4	28,7	1
DBZ 16-3/8	M16FEL3/8N	16MO-8-6	16	3/8	39,5	23,6	29,7	1-1/16
DBZ 16-1/2	M16FEL1/2N	16MO-8-8	16	1/2	39,5	28,4	29,7	1-1/16

NOTE: C dimension is typical finger-tight.

Dimensions for reference only, subject to change.

## MBZ, FRTN NPT Female Run Tee

*For fractional tube*

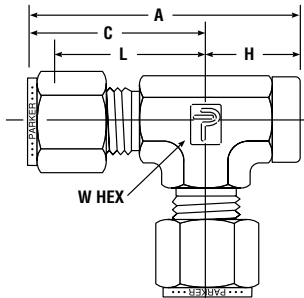
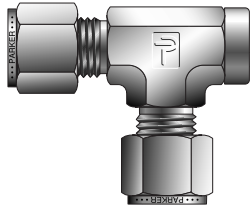

CPI™ PART NO.	A-LOK® PART NO.	INTER- CHANGES WITH	INCHES						
			TUBE O.D.	NPT PIPE THREAD	A	C	H	L	W HEX
2-2-2 MBZ	2FRT2N	200-3-2TFT	1/8	1/8	1.72	.96	.75	.70	1/2
3-2-3 MBZ	3FRT2N	300-3-2TFT	3/16	1/8	1.76	1.01	.75	.74	1/2
4-2-4 MBZ	4FRT2N	400-3-2TFT	1/4	1/8	1.81	1.06	.75	.77	1/2
4-4-4 MBZ	4FRT4N	400-3-4TFT	1/4	1/4	2.05	1.17	.88	.88	11/16
5-2-5 MBZ	5FRT2N	500-3-2TFT	5/16	1/8	1.92	1.17	.75	.88	5/8
6-4-6 MBZ	6FRT4N	600-3-4TFT	3/8	1/4	2.11	1.23	.88	.94	11/16
8-4-8 MBZ	8FRT4N	810-3-4TFT	1/2	1/4	2.56	1.42	.88	1.02	13/16
8-6-8 MBZ	8FRT6N	810-3-6TFT	1/2	3/8	2.30	1.42	.88	1.02	7/8
8-8-8 MBZ	8FRT8N	810-3-8TFT	1/2	1/2	2.66	1.53	1.13	1.13	1
10-8-10 MBZ	10FRT8N	1010-3-8TFT	5/8	1/2	2.70	1.57	1.13	1.17	1-1/16
12-12-12 MBZ	12FRT12N	1210-3-12TFT	3/4	3/4	3.01	1.76	1.25	1.36	1-3/8
14-8-14 MBZ	14FRT8N	1410-3-8TFT	7/8	1/2	3.01	1.76	1.25	1.36	1-3/8
14-12-14 MBZ	14FRT12N	1410-3-12TFT	7/8	3/4	3.01	1.76	1.25	1.36	1-3/8
16-12-16 MBZ	16FRT12N	1610-3-12TFT	1	3/4	3.18	1.93	1.25	1.45	1-3/8
16-16-16 MBZ	16FRT16N	1610-3-16TFT	1	1	3.52	2.02	1.50	1.65	1-3/8

NOTE: A and C dimensions are typical finger-tight.

Dimensions for reference only, subject to change.

## MBZ, FRTN NPT Female Run Tee

*For metric tube*

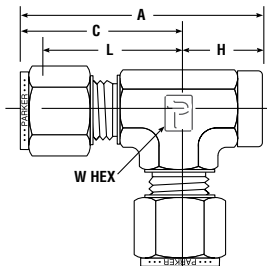
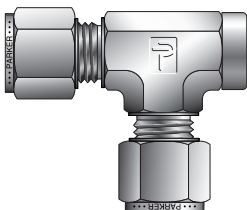

CPI™ PART NO.	A-LOK® PART NO.	INTER- CHANGES WITH	MILLIMETERS						INCH
			TUBE O.D.	NPT THREAD	A	C	H	L	W HEX
MBZ 6-1/8-6	M6FRT1/8N	6MO-3TFT	6	1/8	46,0	27,0	19,0	19,6	1/2
MBZ 6-1/4-6	M6FRT1/4N	6MO-3-4TFT	6	1/4	52,1	29,8	22,4	22,4	11/16
MBZ 6-1/8-6	M8FRT1/8N	8MO-3TFT	8	1/8	48,9	29,9	19,0	22,4	5/8
MBZ 10-1/4-10	M10FRT1/4N	10MO-3TFT	10	1/4	55,9	33,5	22,4	25,9	13/16
MBZ 12-1/4-12	M12FRT1/4N	12MO-3-4TFT	12	1/4	58,4	36,0	22,4	25,9	13/16
MBZ 12-3/8-12	M12FRT3/8N	12MO-3TFT	12	3/8	58,4	36,0	22,4	25,9	13/16
MBZ 12-1/2-12	M12FRT1/2N	12MO-3-8TFT	12	1/2	67,3	38,8	28,5	28,7	1
MBZ 16-1/2-16	M16FRT1/2N	16MO-3TFT	16	1/2	68,2	39,8	28,4	29,7	1-1/16

NOTE: A and C dimensions are typical finger-tight.

Dimensions for reference only, subject to change.

## Color Coding

For easy reference, table heads are color indicated as follows:

fractional



metric





## OBZ, FBTN NPT Female Branch Tee For fractional tube

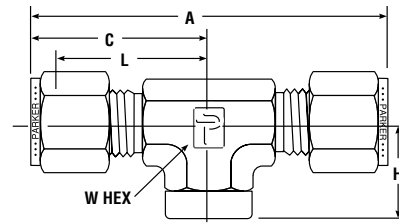
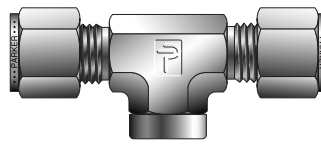

CPI™ PART NO.	A-LOK® PART NO.	INTER- CHANGES WITH	INCHES						
			TUBE O.D.	NPT PIPE THREAD	A	C	H	L	W HEX
2-2-2 OBZ	2FBT2N	200-3-2TTF	1/8	1/8	1.91	1.01	.75	.70	1/2
3-3-2 OBZ	3FBT2N	300-3-2TTF	3/16	1/8	2.02	1.01	.75	.74	1/2
4-4-2 OBZ	4FBT2N	400-3-2TTF	1/4	1/8	2.12	1.06	.75	.77	1/2
4-4-4 OBZ	4FBT4N	400-3-4TTF	1/4	1/4	2.34	1.17	.88	.88	11/16
5-5-2 OBZ	5FBT2N	500-3-2TTF	5/16	1/8	2.34	1.17	.75	.88	5/8
6-6-4 OBZ	6FBT4N	600-3-4TTF	3/8	1/4	2.46	1.23	.88	.94	11/16
8-8-4 OBZ	8FBT4N	810-3-4TTF	1/2	1/4	2.84	1.42	.88	1.02	13/16
8-8-6 OBZ	8FBT6N	810-3-6TTF	1/2	3/8	2.84	1.42	.88	1.02	7/8
8-8-8 OBZ	8FBT8N	810-3-8TTF	1/2	1/2	3.06	1.53	1.13	1.13	1
10-10-8 OBZ	10FBT8N	1010-3-8TTF	5/8	1/2	3.06	1.53	1.13	1.13	1
12-12-12 OBZ	12FBT12N	1210-3-12TTF	3/4	3/4	3.52	1.76	1.25	1.36	1-3/8
14-14-12 OBZ	14FBT12N	1410-3-12TTF	7/8	3/4	3.52	1.76	1.25	1.36	1-3/8
16-16-12 OBZ	16FBT12N	1610-3-12TTF	1	3/4	3.86	1.94	1.25	1.45	1-3/8
16-16-16 OBZ	16FBT16N	1610-3-16TTF	1	1	4.28	2.14	1.50	1.65	1-5/8

NOTE: A and C dimensions are typical finger-tight.

Dimensions for reference only, subject to change.

## OBZ, FBTN NPT Female Branch Tee For metric tube

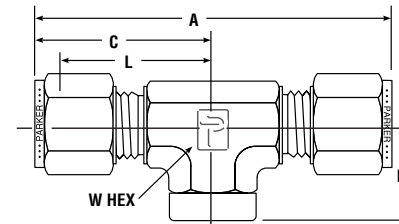
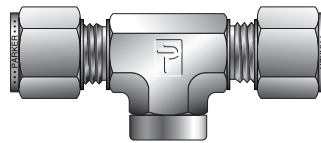

CPI™ PART NO.	A-LOK® PART NO.	INTER- CHANGES WITH	MILLIMETERS							INCH
			TUBE O.D.	NPT THREAD	A	C	H	L	W HEX	
OBZ 6-6-1/8	M6FBT1/8N	6MO-3TTF	6	1/8	53,9	27,0	19,0	19,6	1/2	
OBZ 6-6-1/4	M6FBT1/4N	6MO-3-4TTF	6	1/4	59,5	29,8	22,4	22,4	11/16	
OBZ 8-8-1/8	M8FBT1/8N	8MO-3TTF	8	1/8	59,7	29,9	19,0	22,4	5/8	
OBZ 10-10-1/4	M10FBT1/4N	10MO-3TTF	10	1/4	67,0	33,5	22,4	25,9	13/16	
OBZ 12-12-1/8	M12FBT1/8N	12MO-3TTF	12	1/8	72,0	36,0	22,3	25,9	13/16	
OBZ 12-12-1/4	M12FBT1/4N	12MO-3-4TTF	12	1/4	72,0	36,0	22,3	25,9	13/16	
OBZ 12-12-3/8	M12FBT3/8N	12MO-3TTF	12	3/8	72,0	36,0	22,4	25,9	13/16	
OBZ 12-12-1/2	M12FBT1/2N	12MO-3-8TTF	12	1/2	77,6	38,8	28,5	28,7	1	
OBZ 16-16-1/2	M16FBT1/2N	16MO-3TTF	16	1/2	77,6	38,8	28,4	28,7	1	

NOTE: A and C dimensions are typical finger-tight.

Dimensions for reference only, subject to change.

## HBZ, SC Union For fractional tube

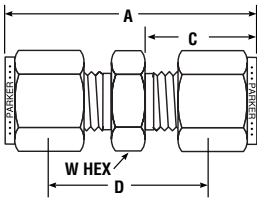
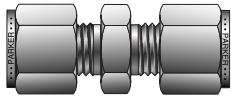

CPI™ PART NO.	A-LOK® PART NO.	INTER- CHANGES WITH	INCHES				
			TUBE O.D.	A	C	D	W HEX
1-1 HBZ	1SC1	100-6	1/16	.99	.43	.69	5/16
2-2 HBZ	2SC2	200-6	1/8	1.39	.60	.88	7/16
3-3 HBZ	3SC3	300-6	3/16	1.48	.64	.95	7/16
4-4 HBZ	4SC4	400-6	1/4	1.62	.70	1.03	1/2
5-5 HBZ	5SC5	500-6	5/16	1.70	.73	1.11	9/16
6-6 HBZ	6SC6	600-6	3/8	1.77	.76	1.19	5/8
8-8 HBZ	8SC8	810-6	1/2	2.02	.87	1.22	13/16
10-10 HBZ	10SC10	1010-6	5/8	2.05	.87	1.25	15/16
12-12 HBZ	12SC12	1210-6	3/4	2.11	.87	1.31	1-1/16
14-14 HBZ	14SC14	1410-6	7/8	2.18	.87	1.38	1-3/16
16-16 HBZ	16SC16	1610-6	1	2.57	1.05	1.59	1-3/8
20-20 HBZ	20SC20	2010-6	1-1/4	3.61	1.52	1.89	1-3/4
24-24 HBZ	24SC24	2410-6	1-1/2	4.23	1.77	2.11	2-1/8
32-32 HBZ	32SC32	3210-6	2	5.88	2.47	2.94	2-3/4

NOTE: A and C dimensions are typical finger-tight.

Dimensions for reference only, subject to change.

## HBZ, SCM Union For metric tube

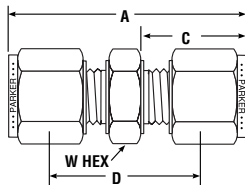
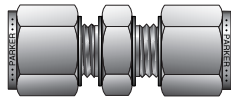

CPI™ PART NO.	A-LOK® PART NO.	INTER- CHANGES WITH	MILLIMETERS				
			TUBE O.D.	A	C	D	W HEX
HBZ 2-2	SCM2	2MO-6	2	35,6	15,3	22,4	12,0
HBZ 3-3	SCM3	3MO-6	3	35,3	15,3	22,1	12,0
HBZ 4-4	SCM4	4MO-4	4	37,4	16,1	24,2	12,0
HBZ 6-6	SCM6	6MO-6	6	41,2	17,7	26,2	14,0
HBZ 8-8	SCM8	8MO-6	8	43,2	18,6	28,2	15,0
HBZ 10-10	SCM10	10MO-6	10	46,2	19,5	31,0	18,0
HBZ 12-12	SCM12	12MO-6	12	51,2	22,0	31,0	22,0
HBZ 14-14	SCM14	14MO-6	14	52,0	22,0	31,8	24,0
HBZ 15-15	SCM15	15MO-6	15	52,0	22,0	31,8	24,0
HBZ 16-16	SCM16	16MO-6	16	52,0	22,0	31,8	24,0
HBZ 18-18	SCM18	18MO-6	18	53,5	22,0	33,3	27,0
HBZ 20-20	SCM20	20MO-6	20	55,0	22,0	34,8	30,0
HBZ 22-22	SCM22	22MO-6	22	55,0	22,0	34,8	30,0
HBZ 25-25	SCM25	25MO-6	25	65,1	26,5	40,5	35,0

NOTE: A and C dimensions are typical finger-tight.

Dimensions for reference only, subject to change.

## Color Coding

For easy reference, table heads are color indicated as follows:

fractional



metric



## HBZ, CU Conversion Union

For metric tube

Metric Tube to Inch Tube

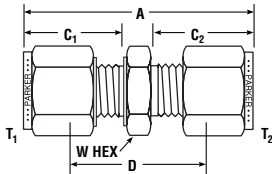
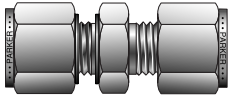

CPI™ PART NO.	A-LOK® PART NO.	INTER-CHANGES WITH	TUBE O.D.		MILLIMETERS				
			T <sub>1</sub> MM	T <sub>2</sub> INCH	A	C <sub>1</sub>	C <sub>2</sub>	D	W HEX
HBZ 3-1/8	M3CU2	3MO-6-2	3	1/8	36,3	15,3	15,3	22,6	12,0
HBZ 4-1/8	M4CU2	4MO-6-2	4	1/8	36,5	16,1	15,3	23,6	12,0
HBZ 4-1/4	M4CU4	4MO-6-4	4	1/4	39,3	16,1	17,7	26,4	14,0
HBZ 6-1/8	M6CU2	6MO-6-2	6	1/8	38,5	17,7	15,3	24,6	14,0
HBZ 6-1/4	M6CU4	6MO-6-4	6	1/4	41,1	17,7	17,7	25,9	14,0
HBZ 6-5/16	M6CU5	6MO-6-5	6	5/16	42,3	17,7	18,8	27,2	14,0
HBZ 8-1/4	M8CU4	8MO-6-4	8	1/4	42,3	18,6	17,7	27,2	15,0
HBZ 8-6	M8CU6	8MO-6-6	8	6	44,0	18,6	19,3	29,1	15,0
HBZ 10-1/8	M10CU2	10MO-6-2	10	1/8	41,8	19,5	15,3	27,9	18,0
HBZ 10-1/4	M10CU4	10MO-6-4	10	1/4	44,5	19,5	17,7	29,2	18,0
HBZ 10-3/8	M10CU6	10MO-6-6	10	3/8	46,0	19,5	19,3	30,7	18,0
HBZ 12-3/8	M12CU6	12MO-6-6	12	3/8	48,4	22,0	19,3	30,7	22,0
HBZ 12-1/2	M12CU8	12MO-6-8	12	1/2	51,1	22,0	21,8	31,0	22,0
HBZ 15-1/2	M15CU8	15MO-6-8	15	1/2	52,0	22,0	21,8	32,0	24,0
HBZ 16-3/8	M16CU6	16MO-6-6	16	3/8	52,0	22,0	19,3	34,3	24,0
HBZ 18-3/4	M18CU12	18MO-6-12	18	3/4	53,5	22,0	21,8	33,5	27,0

NOTE: A, C<sub>1</sub> and C<sub>2</sub> dimensions are typical finger-tight.

Dimensions for reference only, subject to change.

## HBZ, RU Reducing Union

For fractional tube

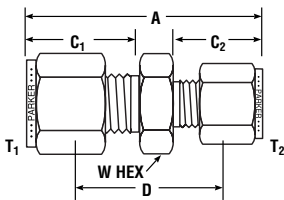
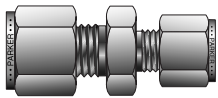

CPI™ PART NO.	A-LOK® PART NO.	INTER-CHANGES WITH	INCHES						
			T <sub>1</sub> TUBE O.D.	T <sub>2</sub> TUBE O.D.	A	D	C <sub>1</sub>	C <sub>2</sub>	W HEX
2-1 HBZ	2RU1	200-6-1	1/8	1/16	1.21	.81	.60	.43	7/16
3-1 HBZ	3RU1	300-6-1	3/16	1/16	1.27	.86	.64	.43	7/16
3-2 HBZ	3RU2	300-6-2	3/16	1/8	1.44	.92	.64	.60	7/16
4-1 HBZ	4RU1	400-6-1	1/4	1/16	1.38	.91	.70	.43	1/2
4-2 HBZ	4RU2	400-6-2	1/4	1/8	1.52	.97	.70	.60	1/2
4-3 HBZ	4RU3	400-6-3	1/4	3/16	1.55	1.00	.70	.64	1/2
5-2 HBZ	5RU2	500-6-2	5/16	1/8	1.58	1.03	.73	.60	9/16
5-4 HBZ	5RU4	500-6-4	5/16	1/4	1.67	1.08	.73	.70	9/16
6-1 HBZ	6RU1	600-6-1	3/8	1/16	1.44	1.00	.76	.43	5/8
6-2 HBZ	6RU2	600-6-2	3/8	1/8	1.61	1.06	.76	.60	5/8
6-4 HBZ	6RU4	600-6-4	3/8	1/4	1.71	1.13	.76	.70	5/8
6-5 HBZ	6RU5	600-6-5	3/8	5/16	1.75	1.16	.76	.73	5/8
8-2 HBZ	8RU2	810-6-2	1/2	1/8	1.75	1.09	.87	.60	13/16
8-4 HBZ	8RU4	810-6-4	1/2	1/4	1.85	1.16	.87	.70	13/16
8-6 HBZ	8RU6	810-6-6	1/2	3/8	1.91	1.22	.87	.76	13/16
10-6 HBZ	10RU6	1010-6-6	5/8	3/8	1.94	1.25	.87	.76	15/16
10-8 HBZ	10RU8	1010-6-8	5/8	1/2	2.05	1.25	.87	.87	15/16
12-4 HBZ	12RU4	1210-6-4	3/4	1/4	1.95	1.25	.87	.76	1-1/16
12-6 HBZ	12RU6	1210-6-6	3/4	3/8	2.00	1.31	.87	.76	1-1/16
12-8 HBZ	12RU8	1210-6-8	3/4	1/2	2.11	1.31	.87	.87	1-1/16
12-10 HBZ	12RU10	1210-6-10	3/4	5/8	2.11	1.31	.87	.87	1-1/16
16-8 HBZ	16RU8	1610-6-8	1	1/2	2.39	1.50	1.05	.87	1-3/8
16-12 HBZ	16RU12	1610-6-12	1	3/4	2.39	1.50	1.05	.87	1-3/8

NOTE: A, C<sub>1</sub> and C<sub>2</sub> dimensions are typical finger-tight.

Dimensions for reference only, subject to change.

## HBZ, RUM Reducing Union

For metric tube

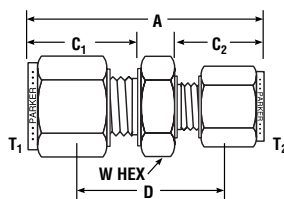
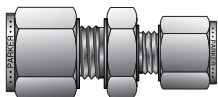

CPI™ PART NO.	A-LOK® PART NO.	INTER-CHANGES WITH	MILLIMETERS						
			T <sub>1</sub> TUBE O.D.	T <sub>2</sub> TUBE O.D.	A	C <sub>1</sub>	C <sub>2</sub>	D	W HEX
HBZ 3-2	M3RUM2	3MO-6-2M	3	2	35,8	15,3	15,3	22,6	12,0
HBZ 6-2	M6RUM2	6MO-6-2M	6	2	38,7	17,7	15,3	24,6	14,0
HBZ 6-3	M6RUM3	6MO-6-3M	6	3	38,7	17,7	15,3	24,6	14,0
HBZ 6-4	M6RUM4	6MO-6-4M	6	4	39,5	17,7	16,1	25,4	14,0
HBZ 8-6	M8RUM6	8MO-6-6M	8	6	42,4	18,6	17,7	27,4	15,0
HBZ 10-6	M10RUM6	10MO-6-6M	10	6	44,5	19,5	17,7	29,4	18,0
HBZ 10-8	M10RUM8	10MO-6-8M	10	8	44,5	19,5	18,6	29,4	18,0
HBZ 12-6	M12RUM6	12MO-6-6M	12	6	47,0	22,0	17,7	29,4	22,0
HBZ 12-8	M12RUM8	12MO-6-8M	12	8	47,8	22,0	18,6	30,2	22,0
HBZ 12-10	M12RUM10	12MO-6-10M	12	10	48,7	22,0	19,5	31,0	22,0
HBZ 16-10	M16RUM10	16MO-6-10M	16	10	49,5	22,0	19,5	31,8	24,0
HBZ 16-12	M16RUM12	16MO-6-12M	16	12	52,0	22,0	22,0	31,8	24,0
HBZ 18-12	M18RUM12	18MO-6-12M	18	12	53,5	22,0	22,0	33,3	27,0
HBZ 25-18	M25RUM18	25MO-6-18M	25	18	60,5	26,5	22,0	38,1	35,0
HBZ 25-20	M25RUM20	25MO-6-20M	25	20	62,3	26,5	22,0	39,9	35,0

NOTE: A, C<sub>1</sub> and C<sub>2</sub> dimensions are typical finger-tight.

Dimensions for reference only, subject to change.

## WBZ, BC Bulkhead Union For fractional tube

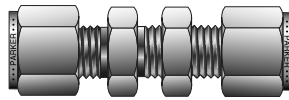

CPI™ PART NO.	A-LOK® PART NO.	INTER- CHANGES WITH	INCHES									
			TUBE O.D.	A	C <sub>1</sub>	D	C <sub>2</sub>	L <sub>1</sub>	L <sub>2</sub>	W HEX	BULKHEAD HOLE DRILL SIZE	MAXIMUM BULKHEAD THICKNESS
1-1 WBZ	1BC1	100-61	1/16	1.23	.43	.94	.68	.28	.53	5/16	13/64	1/8
2-2 WBZ	2BC2	200-61	1/8	2.02	.60	1.50	1.23	.34	.97	1/2	21/64	1/2
3-3 WBZ	3BC3	300-61	3/16	2.11	.64	1.59	1.26	.38	1.00	9/16	25/64	1/2
4-2 WBZ	4BC2	400-61-2	1/4	2.17	.70	1.03	1.23	.41	.97	5/8	21/64	1/2
4-4 WBZ	4BC4	400-61	1/4	2.27	.70	1.69	1.31	.41	1.02	5/8	29/64	17/32
5-5 WBZ	5BC5	500-61	5/16	2.40	.73	1.81	1.42	.44	1.12	11/16	33/64	9/16
6-6 WBZ	6BC6	600-61	3/8	2.46	.76	1.88	1.44	.47	1.15	3/4	37/64	9/16
8-8 WBZ	8BC8	810-61	1/2	2.80	.87	2.00	1.65	.47	1.25	15/16	49/64	19/32
10-10 WBZ	10BC10	1010-61	5/8	2.86	.87	2.06	1.68	.47	1.28	1-1/16	57/64	19/32
12-12 WBZ	12BC12	1210-61	3/4	3.11	.87	2.31	1.87	.47	1.47	1-3/16	1-1/64	25/32
14-14 WBZ	14BC14	1410-61	7/8	3.33	.87	2.53	2.09	.47	1.69	1-3/8	1-9/64	15/16
16-16 WBZ	16BC16	1610-61	1	3.78	1.05	2.81	2.27	.56	1.78	1-5/8	1-21/64	15/16

NOTE: For reducer sizes call out short end first.  
A, C<sub>1</sub> and C<sub>2</sub> dimensions are typical finger-tight.  
For replacement bulkhead nuts, see Page 73, Part WLZ.

Dimensions for reference only, subject to change.

## WBZ, BCM Bulkhead Union For metric tube

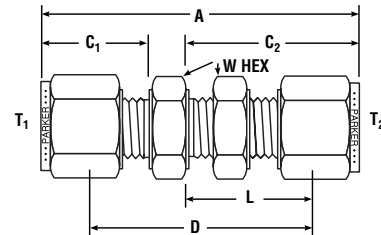
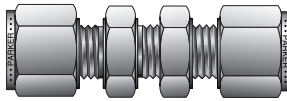

CPI™ PART NO.	A-LOK® PART NO.	INTER- CHANGES WITH	MILLIMETERS									
			TUBE O.D.	A	C <sub>1</sub>	C <sub>2</sub>	D	L	W HEX	B' HEAD HOLE DRILL SIZE	MAX. B' HEAD THICK.	
WBZ 3-3	BCM3	3MO-61	3	51,3	15,3	31,2	38,2	24,6	14,0	8,3	12,7	
WBZ 4-4	BCM4	4MO-61	4	53,7	16,1	32,0	40,5	25,4	14,0	9,9	12,7	
WBZ 6-6	BCM6	6MO-61	6	57,9	17,7	33,7	42,9	26,2	16,0	11,5	10,2	
WBZ 8-8	BCM8	8MO-61	8	61,0	18,6	36,0	46,0	28,5	18,0	13,1	11,2	
WBZ 10-10	BCM10	10MO-61	10	63,6	19,5	37,0	48,4	29,4	22,0	16,3	11,2	
WBZ 12-12	BCM12	12MO-61	12	71,0	22,0	41,9	50,8	31,8	24,0	19,5	12,7	
WBZ 15-15	BCM15	15MO-61	15	72,5	22,0	42,6	52,3	32,5	27,0	22,5	12,7	
WBZ 16-16	BCM16	16MO-61	16	72,6	22,0	42,6	52,4	32,5	27,0	22,5	12,7	
WBZ 18-18	BCM18	18MO-61	18	78,9	22,0	47,4	58,7	37,3	30,0	26,0	16,8	
WBZ 20-20	BCM20	20MO-61	20	88,2	22,0	51,0	68,0	40,9	35,0	29,0	19,0	
WBZ 25-25	BCM25	25MO-61	25	95,8	26,5	54,4	71,4	42,2	41,0	33,8	24,0	

NOTE: A, C<sub>1</sub> and C<sub>2</sub> dimensions are typical finger-tight.  
For replacement bulkhead nuts, see Page 73, Part BN.  
For reducer sizes call out short end first.

Dimensions for reference only, subject to change.

## Color Coding

For easy reference, table heads are color indicated as follows:

fractional



metric

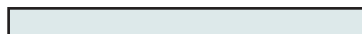

## DEBTA, DELTA Dielectric Union Adapter For fractional tube

includes nuts, machined tube with molded ferrule, preset ferrule, and dielectric identification ring

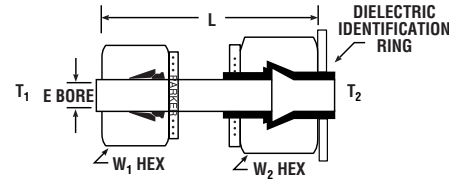
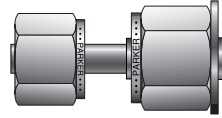

CPI™ ADAPTER PART NO.	A-LOK® ADAPTER PART NO.	INCHES					
		TUBE END T <sub>1</sub>	TUBE END T <sub>2</sub>	L	E BORE	W <sub>1</sub> HEX	W <sub>2</sub> HEX
6-8 DEBTA-SS 8-10 DEBT2-SS	6-8 DELTA	3/8 1/2	1/2 5/8	2.08 2.58	.30 .38	11/16 7/8	7/8 1

**NOTE:** Makeup instructions included with parts in box when ordered as an Adapter only.  
\*Other end connectors available upon request. Dimensions for reference only, subject to change.

## DEBTA, DELTA Dielectric Assembly For fractional tube

includes dielectric union adapter with assembled tube fitting unions

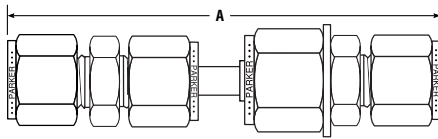
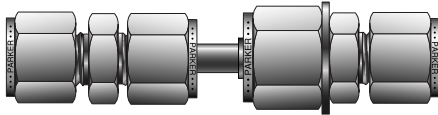

CPI™ ASSEMBLY PART NO.	A-LOK® ASSEMBLY PART NO.	INCHES		
*COMPRESSION	*COMPRESSION	A†	ADAPTER	END CONNECTORS
4H DEBTA 6H DEBTA 8H DEBTA	4H DELTA 6H DELTA 8H DELTA	4.08 4.20 4.79	6-8 DELTA 6-8 DELTA 8-10 DELTA	6RU4/8RU4 6SC6/8RU6 8SC8/10RU8

*COMPRESSION-FEMALE PIPE	*COMPRESSION-FEMALE PIPE	A	ADAPTER	END CONNECTORS
4GDEBTA 6G DEBTA 8G DEBTA	4G DELTA 6G DELTA 8G DELTA	3.59 3.71 4.40	6-8 DELTA 6-8 DELTA 8-10 DELTA	6FSC4N/8FSC4N 6FSC6N/8FSC6N 8FSC8N/10FSC8N

*COMPRESSION-MALE PIPE	*COMPRESSION-MALE PIPE	A	ADAPTER	END CONNECTORS
4F DEBTA 6F DEBTA 8F DEBTA	4F DELTA 6F DELTA 8F DELTA	3.80 3.80 4.58	6-8 DELTA 6-8 DELTA 8-10 DELTA	6MSC4N/8MSC4N 6MSC6N/8MSC6N 8MSC8N/10MSC8N

†Finger tight assembly dimensions. Dimensions for reference only, subject to change.

## EBZ, EE Union Elbow For fractional tube

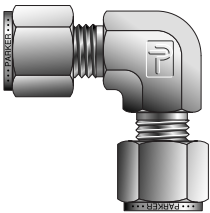

CPI™ PART NO.	A-LOK® PART NO.	INTER- CHANGES WITH	INCHES			
			TUBE O.D.	C	L	W HEX
1-1 EBZ 2-2 EBZ 3-3 EBZ 4-4 EBZ 5-5 EBZ	1EE1 2EE2 3EE3 4EE4 5EE5	100-9 200-9 300-9 400-9 500-9	1/16 1/8 3/16 1/4 5/16	.70 .88 1.00 1.06 1.13	.55 .62 .74 .77 .84	3/8 3/8 1/2 1/2 9/16
6-6 EBZ 8-8 EBZ 10-10 EBZ 12-12 EBZ 14-14 EBZ	6EE6 8EE8 10EE10 12EE12 14EE14	600-9 810-9 1010-9 1210-9 1410-9	3/8 1/2 5/8 3/4 7/8	1.20 1.42 1.50 1.57 1.76	.91 1.02 1.10 1.17 1.36	5/8 13/16 15/16 1-1/16 1-3/8
16-16 EBZ 20-20 EBZ 24-24 EBZ 32-32 EBZ	16EE16 20EE20 24EE24 32EE32	1610-9 2010-9 2410-9 3210-9	1 1-1/4 1-1/2 2	1.93 2.61 3.06 4.22	1.45 1.75 2.00 2.75	1-3/8 1-5/8 1-7/8 2-13/16

**NOTE:** C dimension is typical finger-tight. Dimensions for reference only, subject to change.  
Sizes 20, 24, 32 require additional lubrication prior to assembly.

## EBZ, EEM Union Elbow

For metric tube

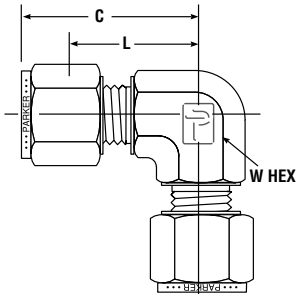
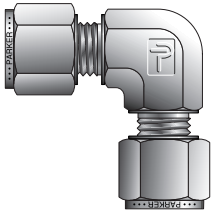

CPI™ PART NO.	A-LOK® PART NO.	INTER-CHANGES WITH	MILLIMETERS			INCH
			TUBE O.D.	C	L	W HEX
EBZ 3-3 EBZ 4-4 EBZ 6-6 EBZ 8-8 EBZ 10-10	EEM3 EEM4 EEM6 EEM8 EEM10	3MO-9 4MO-9 6MO-9 8MO-9 10MO-9	3 4 6 8 10	22,3 25,4 27,0 28,8 31,5	15,7 18,8 19,6 21,3 23,9	3/8 1/2 1/2 9/16 11/16
EBZ 12-12 EBZ 14-14 EBZ 15-15 EBZ 16-16 EBZ 18-18	EEM12 EEM14 EEM15 EEM16 EEM18	12MO-9 14MO-9 15MO-9 16MO-9 18MO-9	12 14 15 16 18	36,0 38,1 38,0 38,0 39,8	25,9 28,0 27,9 27,9 29,7	13/16 15/16 15/16 15/16 1-1/16
EBZ 20-20 EBZ 22-22 EBZ 25-25	EEM20 EEM22 EEM25	20MO-9 22MO-9 25MO-9	20 22 25	44,6 44,6 49,1	34,5 34,5 36,8	1-3/8 1-3/8 1-3/8

NOTE: C dimension is typical finger-tight.

Dimensions for reference only, subject to change.

## EBZ, ELZ Drop Size Elbows

For fractional tube

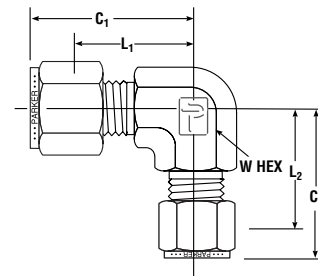
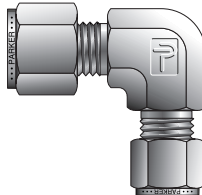

CPI™ PART NO.	A-LOK® PART NO.	INTER-CHANGES WITH	INCHES					
			TUBE O.D.	L <sub>1</sub>	C <sub>1</sub>	L <sub>2</sub>	C <sub>2</sub>	W HEX
3-2 EBZ 4-2 EBZ 5-2 EBZ 5-4 EBZ 6-2 EBZ	3-2 ELZ 4-2 ELZ 5-2 ELZ 5-4 ELZ 6-2 ELZ	300-9-2 400-9-2 500-9-2 500-9-4 600-9-2	3/16-1/8 1/4-1/8 5/16-1/8 5/16-1/4 3/8-1/8	.74 .77 .88 .88 .91	1.01 1.06 1.17 1.17 1.20	.70 .70 .78 .85 .78	.96 .96 1.04 1.14 1.04	1/2 1/2 5/8 5/8 5/8
6-4 EBZ 6-5 EBZ 8-4 EBZ 8-5 EBZ 8-6 EBZ	6-4 ELZ 6-5 ELZ 8-4 ELZ 8-5 ELZ 8-6 ELZ	600-9-4 600-9-5 810-9-4 810-9-5 810-9-6	3/8-1/4 3/8-5/16 1/2-1/4 1/2-5/16 1/2-3/8	.91 .91 1.02 1.02 1.02	1.20 1.20 1.42 1.42 1.42	.85 .88 .96 .99 1.02	1.17 1.17 1.25 1.28 1.31	5/8 5/8 13/16 13/16 13/16
10-6 EBZ 10-8 EBZ 12-4 EBZ 12-6 EBZ 12-8 EBZ	10-6 ELZ 10-8 ELZ 12-4 ELZ 12-6 ELZ 12-8 ELZ	1010-9-6 1010-9-8 1210-9-4 1210-9-6 1210-9-8	5/8-3/8 5/8-1/2 3/4-1/4 3/4-3/8 3/4-1/2	1.10 1.10 1.16 1.16 1.16	1.50 1.50 1.56 1.56 1.56	1.10 1.10 1.10 1.16 1.16	1.39 1.50 1.39 1.45 1.56	15/16 15/16 1-1/16 1-1/16 1-1/16
14-4 EBZ 16-8 EBZ 16-12 EBZ	14-4 ELZ 16-8 ELZ 16-12 ELZ	1410-9-4 1610-9-8 1610-9-12	7/8-1/4 1-1/2 1-3/4	1.36 1.45 1.45	1.76 1.94 1.94	1.30 1.36 1.36	1.59 1.76 1.76	1-3/8 1-3/8 1-3/8

NOTE: C dimension is typical finger-tight.

Dimensions for reference only, subject to change.

## Color Coding

For easy reference, table heads are color indicated as follows:

fractional



metric

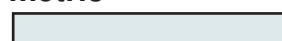

## JBZ, ET Union Tee For fractional tube

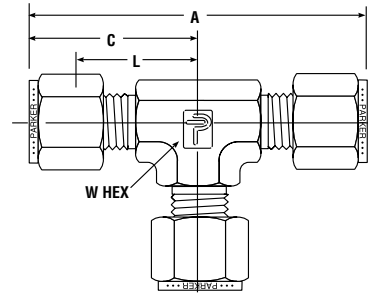
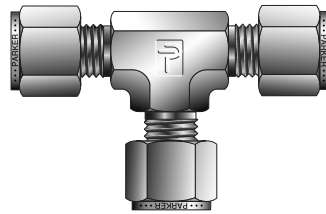

CPI™ PART NO.	A-LOK® PART NO.	INTER- CHANGES WITH	INCHES				
			TUBE O.D.	A	C	L	W HEX
1-1-1 JBZ	1ET1	100-3	1/16	1.42	.71	.56	3/8
2-2-2 JBZ	2ET2	200-3	1/8	1.76	.88	.62	3/8
3-3-3 JBZ	3ET3	300-3	3/16	1.96	.96	.70	7/16
4-4-4 JBZ	4ET4	400-3	1/4	2.12	1.06	.77	1/2
5-5-5 JBZ	5ET5	500-3	5/16	2.34	1.17	.88	5/8
6-6-6 JBZ	6ET6	600-3	3/8	2.40	1.20	.91	5/8
8-8-8 JBZ	8ET8	810-3	1/2	2.84	1.42	1.02	13/16
10-10-10 JBZ	10ET10	1010-3	5/8	3.06	1.53	1.13	1
12-12-12 JBZ	12ET12	1210-3	3/4	3.14	1.57	1.16	1-1/16
14-14-14 JBZ	14ET14	1410-3	7/8	3.52	1.76	1.36	1-3/8
16-16-16 JBZ	16ET16	1610-3	1	3.86	1.93	1.45	1-3/8
20-20-20 JBZ	20ET20	2010-3	1-1/4	5.22	2.61	1.75	1-5/8
24-24-24 JBZ	24ET24	2410-3	1-1/2	6.12	3.06	2.00	1-7/8
32-32-32 JBZ	32ET32	3210-3	2	8.44	4.22	2.75	2-13/16

NOTE: A and C dimensions are typical finger-tight.

Dimensions for reference only, subject to change.

Sizes 20, 24, 32 require additional lubrication prior to assembly.

## JBZ, ETM Union Tee For metric tube

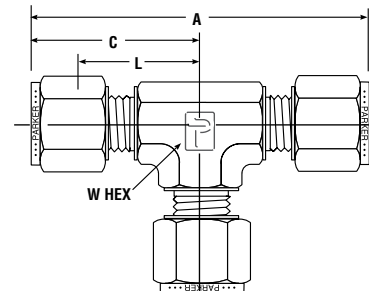
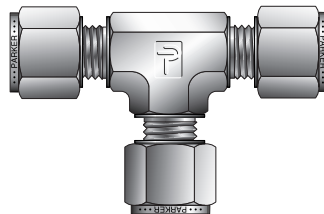

CPI™ PART NO.	A-LOK® PART NO.	INTER- CHANGES WITH	MILLIMETERS		INCH		W HEX
			TUBE O.D.	A	C	L	
JBZ 2-2-2	ETM2	2MO-3	2	44,7	22,3	15,7	3/8
JBZ 3-3-3	ETM3	3MO-3	3	44,7	22,3	15,7	3/8
JBZ 4-4-4	ETM4	4MO-3	4	50,8	25,4	18,8	1/2
JBZ 6-6-6	ETM6	6MO-3	6	53,9	27,0	19,6	1/2
JBZ 8-8-8	ETM8	8MO-3	8	59,7	29,9	22,4	5/8
JBZ 10-10-10	ETM10	10MO-3	10	63,0	31,5	23,9	11/16
JBZ 12-12-12	ETM12	12MO-3	12	72,0	36,0	25,9	13/16
JBZ 14-14-14	ETM14	14MO-3	14	77,6	38,8	28,7	1
JBZ 15-15-15	ETM15	15MO-3	15	77,6	38,8	28,7	1
JBZ 16-16-16	ETM16	16MO-3	16	77,6	38,8	28,7	1
JBZ 18-18-18	ETM18	18MO-3	18	79,5	38,8	29,7	1-1/16
JBZ 20-20-20	ETM20	20MO-3	20	89,3	44,6	34,5	1-3/8
JBZ 22-22-22	ETM22	22MO-3	22	89,3	44,6	34,5	1-3/8
JBZ 25-25-25	ETM25	25MO-3	25	98,3	49,1	36,8	1-3/8

NOTE: A and C dimensions are typical finger-tight.

Dimensions for reference only, subject to change.

## JBZ, JLZ Drop Size Tees

**For fractional tube**

Eliminates the extra connection when adapting with a tube stub reducer

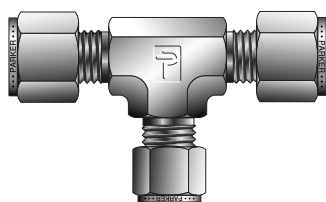

CPI™ PART NO.	A-LOK® PART NO.	INTER- CHANGES WITH	INCHES										
			T <sub>1</sub> TUBE O.D.	T <sub>2</sub> TUBE O.D.	T <sub>3</sub> TUBE O.D.	A	L <sub>1</sub>	C <sub>1</sub>	L <sub>2</sub>	C <sub>2</sub>	L <sub>3</sub>	C <sub>3</sub>	W HEX
4-4-2 JBZ	4-4-2 JLZ	400-3-4-2	1/4	1/4	1/8	2.10	.76	1.05	.76	1.05	.70	.96	1/2
6-6-4 JBZ	6-6-4 JLZ	600-3-6-4	3/8	3/8	1/4	2.40	.91	1.20	.91	1.20	.85	1.14	5/8
6-4-6 JBZ	6-4-6 JLZ	600-3-4-6	3/8	1/4	3/8	2.34	.91	1.20	.85	1.14	.91	1.20	5/8
6-4-4 JBZ	6-4-4 JLZ	600-3-4-4	3/8	1/4	1/4	2.34	.91	1.20	.85	1.14	.85	1.14	5/8
8-8-6 JBZ	8-8-6 JLZ	810-3-8-6	1/2	1/2	3/8	2.84	1.02	1.42	1.02	1.42	1.02	1.31	13/16
8-8-4 JBZ	8-8-4 JLZ	810-3-8-4	1/2	1/2	1/4	2.84	1.02	1.42	1.02	1.42	.96	1.25	13/16
8-6-8 JBZ	8-6-8 JLZ	810-3-6-8	1/2	3/8	1/2	2.73	1.02	1.42	1.02	1.31	1.02	1.42	13/16
8-4-8 JBZ	8-4-8 JLZ	810-3-4-8	1/2	1/4	1/2	2.67	1.02	1.42	.96	1.25	1.02	1.42	13/16
8-6-6 JBZ	8-6-6 JLZ	810-3-6-6	1/2	3/8	3/8	2.73	1.02	1.42	1.02	1.31	1.02	1.31	13/16
8-4-4 JBZ	8-4-4 JLZ	810-3-4-4	1/2	1/4	1/4	2.67	1.02	1.42	.96	1.25	.96	1.25	13/16
10-10-8 JBZ	10-10-8 JLZ	1010-3-10-8	5/8	5/8	1/2	3.06	1.13	1.53	1.13	1.53	1.13	1.53	7/8
10-10-6 JBZ	10-10-6 JLZ	1010-3-10-6	5/8	5/8	3/8	3.06	1.13	1.53	1.13	1.53	1.13	1.53	7/8
10-8-8 JBZ	10-8-8 JLZ	1010-3-8-8	5/8	1/2	1/2	3.06	1.13	1.53	1.13	1.53	1.13	1.53	7/8
10-8-6 JBZ	10-8-6 JLZ	1010-3-8-6	5/8	1/2	3/8	3.06	1.13	1.53	1.13	1.53	1.13	1.42	7/8
10-6-6 JBZ	10-6-6 JLZ	1010-3-6-6	5/8	3/8	3/8	2.95	1.13	1.53	1.13	1.42	1.13	1.42	7/8
10-6-8 JBZ	10-6-8 JLZ	1010-3-6-8	5/8	3/8	1/2	2.95	1.13	1.53	1.13	1.42	1.13	1.53	7/8
12-12-10 JBZ	12-12-10 JLZ	1210-3-12-10	3/4	3/4	5/8	3.12	1.16	1.56	1.16	1.56	1.16	1.56	1-1/16
12-12-8 JBZ	12-12-8 JLZ	1210-3-12-8	3/4	3/4	1/2	3.12	1.16	1.56	1.16	1.56	1.16	1.56	1-1/16
12-12-6 JBZ	12-12-6 JLZ	1210-3-12-6	3/4	3/4	3/8	3.12	1.16	1.56	1.16	1.56	1.16	1.45	1-1/16
12-12-4 JBZ	12-12-4 JLZ	1210-3-12-4	3/4	3/4	1/4	3.12	1.16	1.56	1.16	1.56	1.10	1.39	1-1/16
12-10-10 JBZ	12-10-10 JLZ	1210-3-10-10	3/4	5/8	5/8	3.12	1.16	1.56	1.16	1.56	1.16	1.56	1-1/16
12-8-8 JBZ	12-8-8 JLZ	1210-3-8-8	3/4	1/2	1/2	3.12	1.16	1.56	1.16	1.56	1.16	1.56	1-1/16
12-6-6 JBZ	12-6-6 JLZ	1210-3-6-6	3/4	3/8	3/8	3.01	1.16	1.56	1.16	1.45	1.16	1.45	1-1/16
12-10-8 JBZ	12-10-8 JLZ	1210-3-10-8	3/4	5/8	1/2	3.12	1.16	1.56	1.16	1.56	1.16	1.56	1-1/16
12-10-6 JBZ	12-10-6 JLZ	1210-3-10-6	3/4	5/8	3/8	3.12	1.16	1.56	1.16	1.56	1.16	1.45	1-1/16
12-8-6 JBZ	12-8-6 JLZ	1210-3-8-6	3/4	1/2	3/8	3.12	1.16	1.56	1.16	1.56	1.16	1.45	1-1/16
14-14-6 JBZ	14-14-6 JLZ	1410-3-14-6	7/8	7/8	3/8	3.52	1.36	1.76	1.36	1.76	1.36	1.65	1-3/8
14-14-4 JBZ	14-14-4 JLZ	1410-3-14-4	7/8	7/8	1/4	3.52	1.36	1.76	1.36	1.76	1.30	1.59	1-3/8
14-12-12 JBZ	14-12-12 JLZ	1410-3-12-12	7/8	3/4	3/4	3.52	1.36	1.76	1.36	1.76	1.36	1.76	1-3/8
14-12-8 JBZ	14-12-8 JLZ	1410-3-12-8	7/8	3/4	1/2	3.52	1.36	1.76	1.36	1.76	1.36	1.76	1-3/8
14-12-6 JBZ	14-12-6 JLZ	1410-3-12-6	7/8	3/4	3/8	3.52	1.36	1.76	1.36	1.76	1.36	1.65	1-3/8
14-10-6 JBZ	14-10-6 JLZ	1410-3-10-6	7/8	5/8	3/8	3.52	1.36	1.76	1.36	1.76	1.36	1.65	1-3/8
14-8-12 JBZ	14-8-12 JLZ	1410-3-8-12	7/8	1/2	3/4	3.52	1.36	1.76	1.36	1.76	1.36	1.76	1-3/8
16-16-12 JBZ	16-16-12 JLZ	1610-3-16-12	1	1	3/4	3.88	1.45	1.94	1.45	1.94	1.36	1.76	1-3/8
16-16-10 JBZ	16-16-10 JLZ	1610-3-16-10	1	1	5/8	3.88	1.45	1.94	1.45	1.94	1.36	1.76	1-3/8
16-16-8 JBZ	16-16-8 JLZ	1610-3-16-8	1	1	1/2	3.88	1.45	1.94	1.45	1.94	1.36	1.76	1-3/8
16-16-6 JBZ	16-16-6 JLZ	1610-3-16-6	1	1	3/8	3.88	1.45	1.94	1.45	1.94	1.36	1.65	1-3/8
16-16-4 JBZ	16-16-4 JLZ	1610-3-16-4	1	1	1/4	3.88	1.45	1.94	1.45	1.94	1.30	1.59	1-3/8
16-12-16 JBZ	16-12-16 JLZ	1610-3-12-16	1	3/4	1	3.70	1.45	1.94	1.36	1.76	1.45	1.94	1-3/8
16-14-14 JBZ	16-14-14 JLZ	1610-3-14-14	1	7/8	7/8	3.70	1.45	1.94	1.36	1.76	1.36	1.76	1-3/8
16-14-12 JBZ	16-14-12 JLZ	1610-3-14-12	1	7/8	3/4	3.70	1.45	1.94	1.36	1.76	1.36	1.76	1-3/8
16-14-8 JBZ	16-14-8 JLZ	1610-3-14-8	1	7/8	1/2	3.70	1.45	1.94	1.36	1.76	1.36	1.76	1-3/8
16-14-6 JBZ	16-14-6 JLZ	1610-3-14-6	1	7/8	3/8	3.70	1.45	1.94	1.36	1.76	1.36	1.65	1-3/8
16-14-4 JBZ	16-14-4 JLZ	1610-3-14-4	1	7/8	1/4	3.70	1.45	1.94	1.36	1.76	1.30	1.59	1-3/8
16-16-14 JBZ	16-16-14 JLZ	1610-3-16-14	1	1	7/8	3.88	1.45	1.94	1.45	1.94	1.36	1.76	1-3/8
16-12-10 JBZ	16-12-10 JLZ	1610-3-12-10	1	3/4	5/8	3.70	1.45	1.94	1.36	1.76	1.36	1.76	1-3/8
16-12-8 JBZ	16-12-8 JLZ	1610-3-12-8	1	3/4	1/2	3.70	1.45	1.94	1.36	1.76	1.36	1.76	1-3/8
16-10-6 JBZ	16-10-6 JLZ	1610-3-10-6	1	5/8	3/8	3.70	1.45	1.94	1.36	1.76	1.36	1.65	1-3/8
16-8-16 JBZ	16-8-16 JLZ	1610-3-8-16	1	1/2	1	3.70	1.45	1.94	1.36	1.76	1.45	1.94	1-3/8
16-8-8 JBZ	16-8-8 JLZ	1610-3-8-8	1	1/2	1/2	3.70	1.45	1.94	1.36	1.76	1.36	1.76	1-3/8
16-8-6 JBZ	16-8-6 JLZ	1610-3-8-6	1	1/2	3/8	3.70	1.45	1.94	1.36	1.76	1.36	1.65	1-3/8
16-8-4 JBZ	16-8-4 JLZ	1610-3-8-4	1	1/2	1/4	3.70	1.45	1.94	1.36	1.76	1.30	1.59	1-3/8
16-6-6 JBZ	16-6-6 JLZ	1610-3-6-6	1	3/8	3/8	3.59	1.45	1.94	1.36	1.65	1.36	1.65	1-3/8

NOTE: C dimensions are typical finger-tight.

Dimensions for reference only, subject to change.



## KBZ, ECR Union Cross For fractional tube

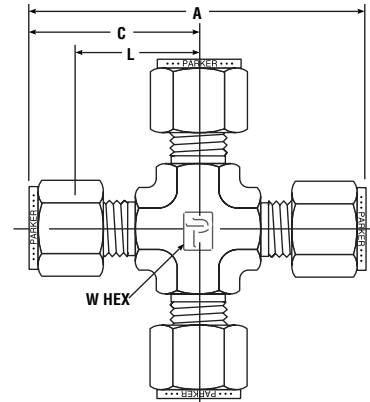
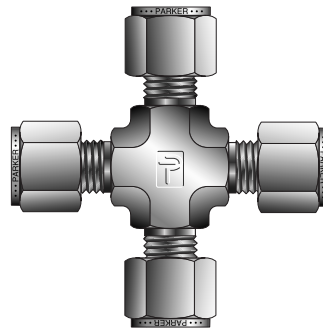

CPI™ PART NO.	A-LOK® PART NO.	INTER- CHANGES WITH	INCHES				
			TUBE O.D.	A	C	L	W HEX
2 KBZ	2ECR2	200-4	1/8	1.76	.98	.62	7/16
3 KBZ	3ECR3	300-4	3/16	1.83	.96	.70	7/16
4 KBZ	4ECR4	400-4	1/4	2.12	1.06	.76	1/2
5 KBZ	5ECR5	500-4	5/16	2.34	1.17	.88	5/8
6 KBZ	6ECR6	600-4	3/8	2.40	1.20	.91	5/8
8 KBZ	8ECR8	810-4	1/2	2.84	1.42	1.02	13/16
10 KBZ	10ECR10	1010-4	5/8	3.06	1.53	1.13	1-1/16
12 KBZ	12ECR12	1210-4	3/4	3.12	1.57	1.16	1-1/16
14 KBZ	14ECR14	1410-4	7/8	3.52	1.76	1.36	1-5/16
16 KBZ	16ECR16	1610-4	1	3.86	1.93	1.45	1-5/16

NOTE: A and C dimensions are typical finger-tight.

Dimensions for reference only, subject to change.

## KBZ, ECRM Union Cross For metric tube

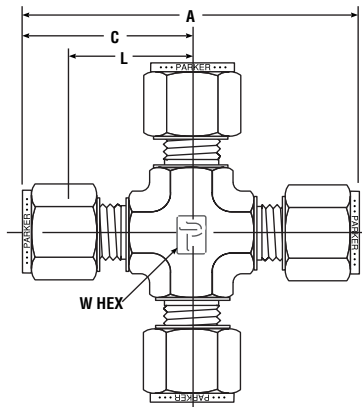

## Color Coding

For easy reference, table heads are color indicated as follows:

**fractional**



**metric**



CPI™ PART NO.	A-LOK® PART NO.	INTER- CHANGES WITH	MILLIMETERS				INCH
			TUBE O.D.	A	C	L	W HEX
KBZ 3	ECRM3	3MO-4	3	44,7	22,3	15,7	7/16
KBZ 4	ECRM4	4MO-4	4	50,8	25,4	18,8	1/2
KBZ 6	ECRM6	6MO-4	6	53,9	27,0	19,6	1/2
KBZ 8	ECRM8	8MO-4	8	59,7	29,9	22,4	5/8
KBZ 10	ECRM10	10MO-4	10	67,0	33,5	25,9	13/16
KBZ 12	ECRM12	12MO-4	12	72,0	36,0	25,9	13/16
KBZ 16	ECRM16	16MO-4	16	74,0	37,0	26,9	15/16
KBZ 18	ECRM18	18MO-4	18	76,6	38,3	28,2	1-1/16

NOTE: A and C dimensions are typical finger-tight.

Dimensions for reference only, subject to change.

## TRBZ, TUR Tube End Reducer For fractional tube

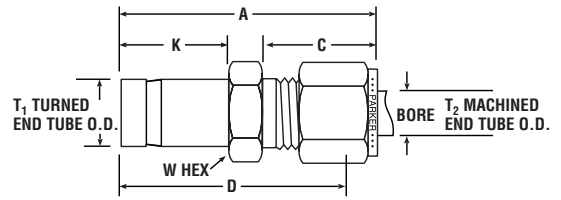
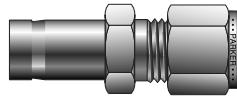

CPI™ PART NO.	A-LOK® PART NO.	INTER- CHANGES WITH	T <sub>1</sub> TURNED END TUBE O.D.	T <sub>2</sub> MACHINE END TUBE O.D.	INCHES					
					A	C	D	K	W HEX	BORE
2-1 TRBZ	2TUR1*	100-R-2	1/8	1/16	1.10	.43	.95	.53	5/16	.05
3-1 TRBZ	3TUR1*	100-R-3	3/16	1/16	1.13	.43	.98	.58	5/16	.05
4-1 TRBZ	4TUR1	100-R-4	1/4	1/16	1.24	.43	1.09	.63	7/16	.05
1-2 TRBZ	1TUR2*	200-R-1	1/16	1/8	1.18	.60	.922	.38	7/16	.09
2-2 TRBZ	2TUR2*	200-R-2	1/8	1/8	1.34	.43	1.09	.54	7/16	.07
3-2 TRBZ	3TUR2*	200-R-3	3/16	1/8	1.35	.60	1.09	.58	7/16	.09
4-2 TRBZ	4TUR2	200-R-4	1/4	1/8	1.42	.60	1.16	.63	7/16	.09
6-2 TRBZ	6TUR2	200-R-6	3/8	1/8	1.48	.60	1.22	.69	7/16	.09
8-2 TRBZ	8TUR2	200-R-8	1/2	1/8	1.74	.60	1.48	.91	9/16	.09
2-3 TRBZ	2TUR3*	300-R-2	1/8	3/16	1.37	.63	1.11	.53	7/16	.08
4-3 TRBZ	4TUR3	300-R-4	1/4	3/16	1.46	.63	1.20	.63	7/16	.13
2-4 TRBZ	2TUR4*	400-R-2	1/8	1/4	1.45	.70	1.16	.53	1/2	.08
3-4 TRBZ	3TUR4*	400-R-3	3/16	1/4	1.48	.60	1.19	.56	1/2	.12
4-4 TRBZ	4TUR4	400-R-4	1/4	1/4	1.54	.70	1.25	.63	1/2	.19
5-4 TRBZ	5TUR4	400-R-5	5/16	1/4	1.57	.70	1.28	.66	1/2	.19
6-4 TRBZ	6TUR4	400-R-6	3/8	1/4	1.60	.70	1.31	.69	1/2	.19
8-4 TRBZ	8TUR4	400-R-8	1/2	1/4	1.82	.70	1.53	.91	9/16	.19
10-4 TRBZ	10TUR4	400-R-10	5/8	1/4	1.89	.70	1.60	.97	11/16	.19
12-4 TRBZ	12TUR4	400-R-12	3/4	1/4	1.88	.70	1.59	.97	13/16	.19
6-5 TRBZ	6TUR5	500-R-6	3/8	5/16	1.65	.73	1.36	.69	9/16	.25
8-5 TRBZ	8TUR5	500-R-8	1/2	5/16	1.87	.73	1.58	.91	9/16	.25
4-6 TRBZ	4TUR6	600-R-4	1/4	3/8	1.63	.76	1.34	.63	5/8	.19
6-6 TRBZ	6TUR6	600-R-6	3/8	3/8	1.70	.76	1.41	.69	5/8	.28
8-6 TRBZ	8TUR6	600-R-8	1/2	3/8	1.91	.76	1.62	.91	5/8	.28
10-6 TRBZ	10TUR6	600-R-10	5/8	3/8	1.98	.76	1.69	.97	11/16	.28
12-6 TRBZ	12TUR6	600-R-12	3/4	3/8	1.98	.76	1.69	.97	13/16	.28
4-8 TRBZ	4TUR8	810-R-4	1/4	1/2	1.77	.87	1.37	.63	13/16	.19
6-8 TRBZ	6TUR8	810-R-6	3/8	1/2	1.84	.87	1.44	.69	13/16	.19
10-8 TRBZ	10TUR8	810-R-10	5/8	1/2	2.12	.87	1.72	.97	13/16	.41
12-8 TRBZ	12TUR8	810-R-12	3/4	1/2	2.12	.87	1.72	.97	13/16	.41
16-8 TRBZ	16TUR8	810-R-16	1	1/2	2.37	.87	1.97	1.22	1-1/16	.41
12-10 TRBZ	12TUR10	1010-R-12	3/4	5/8	2.15	.87	1.75	.97	15/16	.50
14-10 TRBZ	14TUR10	1010-R-14	7/8	5/8	2.21	.87	1.81	1.03	15/16	.50
16-10 TRBZ	16TUR10	1010-R-16	1	5/8	2.40	.87	2.00	1.22	1-1/16	.50
8-12 TRBZ	8TUR12	1210-R-8	1/2	3/4	2.15	.87	1.75	.91	1-1/16	.39
16-12 TRBZ	16TUR12	1210-R-16	1	3/4	2.46	.87	2.06	1.22	1-1/16	.63
24-16-TRBZ	24TUR16	1610-R-24	1-1/2	1	3.519	1.05	3.03	2.05	1-5/8	.88
24-20 TRBZ	24TUR20	2010-R-24	1-1/2	1-1/4	4.10	1.52	3.23	2.05	1-7/8	1.09
32-24 TRBZ	32TUR24	2410-R-32	2	1-1/2	5.17	1.52	4.10	2.74	2-1/4	1.34

NOTE: A and C dimensions are typical finger-tight. Dimensions for reference only, subject to change.

Size 4 and above tube stub is pre-grooved as standard. Generic (non-grooved) can be ordered through Quick Response Department.

\*Size 1, 2, and 3 do not require a groove.

Add -Z6 for assembly of nuts and ferrules on the tube stub end.

Sizes 20, 24 require additional lubrication prior to assembly.

## Color Coding

For easy reference, table heads are color indicated as follows:

fractional



metric



## TRBZ, TUCM Tube End Converter For metric tube

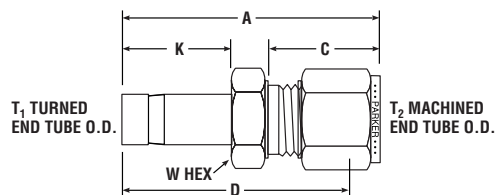
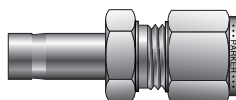

CPI™ PART NO.	A-LOK® PART NO.	INTER- CHANGES WITH	TUBE O.D.		MILLIMETERS					
			T <sub>1</sub> INCH	T <sub>2</sub> MM	A	C	D	K	W A/F HEX	BORE
TRBZ 3-2	2TUCM3	3MO-R-2	1/8	3	34,3	15,3	27,7	13,5	12,0	1,4
TRBZ 3-4	4TUCM3	3MO-R-4	1/4	3	36,1	15,3	29,5	16,0	12,0	4,8
TRBZ 6-4	4TUCM6	6MO-R-4	1/4	6	39,3	17,7	31,8	16,0	14,0	4,8
TRBZ 6-5	5TUCM6	6MO-R-5	5/16	6	40,0	17,7	32,5	16,8	14,0	6,4
TRBZ 6-6	6TUCM6	6MO-R-6	3/8	6	40,8	17,7	33,3	17,5	14,0	7,1
TRBZ 6-8	8TUCM6	6MO-R-8	1/2	6	46,4	17,7	38,9	23,1	14,0	9,9
TRBZ 8-6	6TUCM8	8MO-R-6	3/8	8	42,0	18,6	34,5	17,5	15,0	7,1
TRBZ 10-6	8TUCM8	8MO-R-8	1/2	8	47,5	18,6	40,1	23,1	15,0	9,9
TRBZ 10-6	6TUCM10	10MO-R-6	3/8	10	44,4	19,5	36,8	17,5	18,0	7,1
TRBZ 10-8	8TUCM10	10MO-R-8	1/2	10	47,6	19,5	41,4	23,1	18,0	9,9
TRBZ 12-8	8TUCM12	12MO-R-8	1/2	12	52,3	22,0	42,2	23,1	22,0	9,9
TRBZ 12-12	12TUCM12	12MO-R-12	3/4	12	53,8	22,0	43,7	24,6	22,0	15,1
TRBZ 18-12	12TUCM18	18MO-R-12	3/4	18	57,5	22,0	47,5	24,6	27,0	15,1

**NOTE:** A and C dimensions are typical finger-tight.

Tube stub is pre-grooved as standard. Generic (non-grooved) can be ordered through Quick Response Department.

Size 1, 2, and 3 do not require a groove.

Add -Z6 for assembly of nuts and ferrules on the tube stub end.

Dimensions for reference only, subject to change.

## TRBZ, TURM Tube End Reducer For metric tube

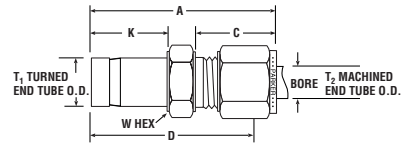
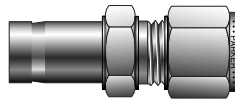

CPI™ PART NO.	A-LOK® PART NO.	INTER- CHANGES WITH	MILLIMETERS								
			TUBE O.D.		A	C	D	K	Q	W HEX	BORE
			T <sub>1</sub>	T <sub>2</sub>							
TRBZ 3-2	M3TURM2	2MO-R-3M	3	2	34,3	15,3	27,7	13,5	0,6	14,0	1,4
TRBZ 3-6	M3TURM6	6MO-R-3M	3	6	37,0	17,7	29,5	13,5	0,6	14,0	1,4
TRBZ 4-3	M4TURM3	3MO-R-4M	4	3	35,0	15,3	28,4	14,3	1,0	12,0	2,0
TRBZ 6-3	M6TURM3	3MO-R-6M	6	3	36,1	15,3	29,5	15,9	1,0	12,0	2,4
TRBZ 6-4	M6TURM4	4MO-R-6M	6	4	37,1	16,1	30,5	15,9	1,0	12,0	3,0
TRBZ 6-8	M6TURM8	8MO-R-6M	6	8	40,0	18,6	32,5	15,9	1,0	15,0	4,0
TRBZ 6-10	M6TURM10	10MO-R-6M	6	10	41,7	19,5	34,1	15,9	1,0	18,0	4,0
TRBZ 6-12	M6TURM12	12MO-R-6M	6	12	44,9	22,0	34,8	15,9	1,0	22,0	4,0
TRBZ 8-6	M8TURM6	6MO-R-8M	8	6	40,0	17,7	32,5	16,7	0,8	14,0	4,8
TRBZ 8-10	M8TURM10	10MO-R-8M	8	10	43,4	19,5	35,8	15,3	1,5	19,5	18,0
TRBZ 10-3	M10TURM3	3MO-R-10M	10	3	38,6	15,3	32,0	17,7	2,0	15,3	12,0
TRBZ 10-6	M10TURM6	6MO-R-10M	10	6	40,8	17,7	33,3	17,5	1,3	14,0	4,8
TRBZ 10-8	M10TURM8	8MO-R-10M	10	8	42,0	18,6	34,5	17,5	1,3	15,0	6,4
TRBZ 10-12	M10TURM12	12MO-R-10M	10	12	46,6	22,0	36,5	17,5	1,3	22,0	7,5
TRBZ 12-6	M12TURM6	6MO-R-12M	12	6	46,4	17,7	38,9	23,0	1,4	14,0	4,8
TRBZ 12-8	M12TURM8	8MO-R-12M	12	8	47,6	18,6	40,1	23,0	1,4	15,0	6,4
TRBZ 12-10	M12TURM10	10MO-R-12M	12	10	49,7	19,5	42,1	23,0	1,4	18,0	7,9
TRBZ 12-16	M12TURM16	16MO-R-12M	12	16	53,0	22,0	42,9	23,0	1,4	24,0	9,1
TRBZ 12-18	M12TURM18	18MO-R-12M	12	18	54,6	22,0	44,5	23,0	1,4	27,0	9,1
TRBZ 15-10	M15TURM10	10MO-R-15M	15	10	51,3	19,5	43,7	23,8	1,6	27,0	7,9
TRBZ 16-12	M16TURM12	12MO-R-16M	16	12	53,8	22,0	43,7	24,6	1,7	22,0	9,5
TRBZ 16-18	M16TURM18	18MO-R-16M	16	18	56,1	22,0	46,0	24,6	1,7	27,0	12,7
TRBZ 16-20	M16TURM20	20MO-R-16M	16	20	57,9	22,0	47,8	24,6	1,7	27,0	12,7
TRBZ 16-25	M16TURM25	25MO-R-16M	16	25	63,2	26,5	51,0	24,8	2,0	26,5	35,0
TRBZ 18-12	M18TURM12	12MO-R-18M	18	12	53,8	22,0	43,7	24,6	2,0	22,0	9,5
TRBZ 18-16	M18TURM16	16MO-R-18M	18	16	54,7	22,0	44,6	24,8	2,5	22,0	24,0
TRBZ 18-20	M18TURM20	20MO-R-18M	18	20	57,9	22,0	47,8	24,6	2,0	30,0	13,9
TRBZ 18-25	M18TURM25	25MO-R-18M	18	25	63,1	26,5	50,8	24,6	2,0	35,0	14,0
TRBZ 20-12	M20TURM12	12MO-R-20M	20	12	56,1	22,0	46,0	25,4	2,5	22,0	9,5
TRBZ 20-16	M20TURM16	16MO-R-20M	20	16	55,3	22,0	45,2	25,6	2,5	22,0	24,0
TRBZ 20-18	M20TURM18	18MO-R-20M	20	18	57,6	22,0	47,5	25,4	2,5	27,0	15,1
TRBZ 20-25	M20TURM25	25MO-R-20M	20	25	64,5	26,5	52,3	25,4	2,5	35,0	15,1
TRBZ 22-18	M22TURM18	18MO-R-22M	22	18	56,1	22,0	46,0	26,2	2,5	27,0	15,1
TRBZ 22-20	M22TURM20	20MO-R-22M	22	20	57,7	22,0	47,6	26,2	2,5	30,0	15,8
TRBZ 25-12	M25TURM12	12MO-R-25M	25	12	60,9	22,0	50,8	31,8	2,6	27,0	9,5
TRBZ 25-16	M25TURM16	16MO-R-25M	25	16	64,0	22,0	51,8	32,0	3,0	22,0	27,0
TRBZ 25-18	M25TURM18	18MO-R-25M	25	18	62,5	22,0	52,4	31,8	2,6	27,0	15,1
TRBZ 25-20	M25TURM20	20MO-R-25M	25	20	64,2	22,0	54,1	31,8	2,6	30,0	15,8

**NOTE:** A and C dimensions are typical finger-tight.  
 Tube stub is pre-grooved as standard.  
 Add -Z6 for assembly of nuts and ferrules on the tube stub end.

Dimensions for reference only, subject to change.

## T2H2B2, TUBC Tube End Bulkhead Adapter For fractional tube

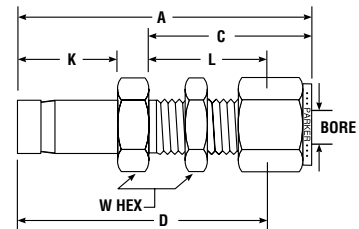
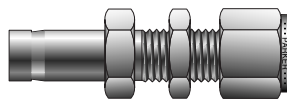

CPI™ PART NO.	A-LOK® PART NO.	INTER- CHANGES WITH	INCHES							
			TUBE O.D.	A	C	L	K	D	BORE	W HEX
2-2 T2H2BZ	2TUBC2	200-R1-2	1/8	1.95	1.23	.97	.53	1.69	.093	1/2
4-4 T2H2BZ	4TUBC4	400-R1-4	1/4	2.20	1.31	1.02	.63	1.91	.187	5/8
6-6 TH2HBZ	6TUBC6	600-R1-6	3/8	2.42	1.44	1.15	.69	2.13	.281	3/4
8-8 T2H2BZ	8TUBC8	810-R1-8	1/2	2.87	1.65	1.25	.91	2.47	.406	15/16

**NOTE:** A and C dimensions are typical finger-tight.  
 Tube stub is pre-grooved as standard. Generic (non-grooved) can be ordered through Quick Response Department.  
 Add -Z6 for assembly of nuts and ferrules on the tube stub end.

Dimensions for reference only, subject to change.

## ZPC, PC Port Connector For fractional tube

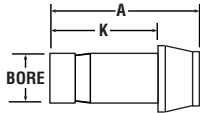
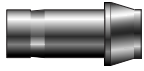

CPI™ PART NO.	A-LOK® PART NO.	INTER- CHANGES WITH	INCHES			
			TUBE O.D.	A	K	BORE
1-1 ZPC	1PC1	101-PC	1/16	.63	.44	.031
1-2 ZPC	1PC2	201-PC-1	1/16-1/8	.84	.44	.031
1-4 ZPC	1PC4	401-PC-1	1/16-1/4	.91	.44	.031
2-2 ZPC	2PC2	201-PC	1/8	.95	.54	.078
2-4 ZPC	2PC4	401-PC-2	1/8-1/4	1.05	.54	.078
2-6 ZPC	2PC6	601-PC-2	1/8-3/8	1.09	.54	.031
3-3 ZPC	3PC3	301-PC	3/16	.981	.67	.116
4-4 ZPC	4PC4	401-PC	1/4	1.07	.76	.156
4-6 ZPC	4PC6	601-PC-4	1/4-3/8	1.15	.64	.156
4-8 ZPC	4PC8	811-PC-4	1/4-1/2	1.36	.64	.156
6-6 ZPC	6PC6	601-PC	3/8	1.16	.84	.281
6-8 ZPC	6PC8	811-PC-6	3/8-1/2	1.40	.72	.281
8-8 ZPC	8PC8	811-PC	1/2	1.59	1.11	.375
8-12 ZPC	8PC12	1211-PC-8	1/2-3/4	1.72	.91	.375
12-12 ZPC	12PC12	1211-PC	3/4	1.65	1.16	.578
16-16 ZPC	16PC16	1611-PC	1	2.12	1.44	.813

Dimensions for reference only, subject to change.

**NOTE:** Tube stub is pre-grooved as standard. (Size 1, 2, and 3 not grooved). Generic (non-grooved 4-16) can be ordered through Quick Response Department.

The machined ferrule end (T<sub>2</sub>) requires only 1/4 turn from finger tight to assemble. Add -Z6 for assembly of nuts and ferrules on the tube stub end.

## ZPC, PCM Port Connector For metric tube

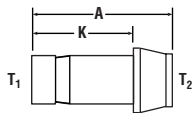
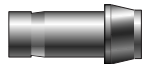

CPI™ PART NO.	A-LOK® PART NO.	INTER- CHANGES WITH	MILLIMETERS				
			TUBE O.D.		A	K	BORE
			T <sub>1</sub>	T <sub>2</sub>			
ZPC 3-3	PCM3	3M1-PC	3	3	22,2	15,7	1,6
ZPC 6-6	PCM6	6M1-PC	6	6	24,6	18,7	3,0
ZPC 8-8	PCM8	8M1-PC	8	8	25,9	20,0	5,0
ZPC 10-10	PCM10	10M1-PC	10	10	26,1	20,2	6,0
ZPC 12-12	PCM12	12M1-PC	12	12	35,8	26,0	8,0
ZPC 16-16	PCM16	16M1-PC	16	16	40,5	27,7	12,0
ZPC 18-18	PCM18	18M1-PC	18	18	40,8	27,7	13,0
ZPC 3-6	M3PCM6	6M1-PC-3M	3	6	22,6	13,5	1,6
ZPC 6-8	M6PCM8	8M1-PC-6M	6	8	25,5	16,1	3,0
ZPC 6-10	M6PCM10	10M1-PC-6M	6	10	25,5	16,1	3,0
ZPC 6-12	M6PCM12	12M1-PC-6M	6	12	31,2	16,1	3,0
ZPC 8-10	M8PCM10	10M1-PC-8M	8	10	29,5	16,8	5,0
ZPC 8-12	M8PCM12	12M1-PC-8M	8	12	31,4	16,8	5,0

Dimensions for reference only, subject to change.

**NOTE:** Tube stub is pre-grooved as standard. (Size M2, M3, and M4 not grooved). The machined ferrule end (T<sub>2</sub>) requires only 1/4 turn from finger tight to assemble. Add -Z6 for assembly of nuts and ferrules on the tube stub end.

## Color Coding

For easy reference, table heads are color indicated as follows:

### fractional



### metric



## T2HF, MAN NPT Tube End Male Adapter For fractional tube

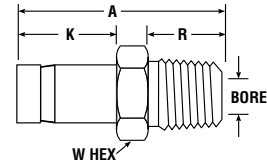
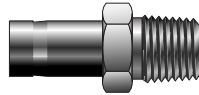

CPI™ PART NO.	A-LOK® PART NO.	INTER- CHANGES WITH	INCHES						
			TUBE O. D.	NPT PIPE THREAD	A	R	K	W HEX	BORE
1-2 T2HF	1MA2N	1-TA-1-1	1/16	1/8	1.00	.38	.38	7/16	.031
2-2 T2HF	2MA2N	2-TA-1-2	1/8	1/8	1.16	.38	.54	7/16	.078
2-4 T2HF	2MA4N	2-TA-1-4	1/8	1/4	1.38	.56	.54	9/16	.078
3-2 T2HF	3MA2N	3-TA-1-2	3/16	1/8	1.20	.38	.58	7/16	.116
3-4 T2HF	3MA4N	3-TA-1-4	3/16	1/4	1.42	.56	.58	9/16	.116
4-2 T2HF	4MA2N	4-TA-1-2	1/4	1/8	1.25	.38	.63	7/16	.156
4-4 T2HF	4MA4N	4-TA-1-4	1/4	1/4	1.46	.56	.63	9/16	.156
4-6 T2HF	4MA6N	4-TA-1-6	1/4	3/8	1.49	.56	.63	11/16	.156
4-8 T2HF	4MA8N	4-TA-1-8	1/4	1/2	1.71	.75	.63	7/8	.156
5-2 T2HF	5MA2N	5-TA-1-2	5/16	1/8	1.29	.38	.66	7/16	.219
5-4 T2HF	5MA4N	5-TA-1-4	5/16	1/4	1.50	.56	.66	9/16	.219
5-6 T2HF	5MA6N	5-TA-1-6	5/16	3/8	1.53	.56	.66	11/16	.219
5-8 T2HF	5MA8N	5-TA-1-8	5/16	1/2	1.74	.75	.66	7/8	.219
6-2 T2HF	6MA2N	6-TA-1-2	3/8	1/8	1.32	.38	.69	7/16	.281
6-4 T2HF	6MA4N	6-TA-1-4	3/8	1/4	1.53	.56	.69	9/16	.281
6-6 T2HF	6MA6N	6-TA-1-6	3/8	3/8	1.56	.56	.69	11/16	.281
6-8 T2HF	6MA8N	6-TA-1-8	3/8	1/2	1.78	.75	.69	7/8	.281
8-4 T2HF	8MA4N	8-TA-1-4	1/2	1/4	1.75	.56	.91	9/16	.281
8-6 T2HF	8MA6N	8-TA-1-6	1/2	3/8	1.78	.56	.91	11/16	.375
8-8 T2HF	8MA8N	8-TA-1-8	1/2	1/2	2.00	.75	.91	7/8	.375
10-8 T2HF	10MA8N	10-TA-1-8	5/8	1/2	2.06	.75	.97	7/8	.469
12-8 T2HF	12MA8N	12-TA-1-8	3/4	1/2	2.06	.75	.97	7/8	.469
12-12 T2HF	12MA12N	12-TA-1-12	3/4	3/4	2.06	.75	.97	1-1/16	.578
12-16 T2HF	12MA16N	12-TA-1-16	3/4	1	2.41	.94	.97	1-3/8	.813
16-12 T2HF	16MA12N	16-TA-1-12	1	3/4	2.31	.75	1.22	1-1/16	.813
16-16 T2HF	16MA16N	16-TA-1-16	1	1	2.68	.94	1.22	1-3/8	.813
20-20 T2HF	20MA20N	20-TA-1-20	1-1/4	1-1/4	3.16	.97	1.71	1-3/4	1.000
24-24 T2HF	24MA24N	24-TA-1-24	1-1/2	1-1/2	3.72	1.00	2.05	2-1/8	1.250
32-32 T2HF	32MA32N	32-TA-1-32	2	2	4.70	1.04	2.74	2-3/4	1.720

**NOTE:** Add -Z6 for assembly of nuts and ferrules on the tube stub end. Dimensions for reference only, subject to change.  
 Tube stub is pre-grooved as standard. Generic (non-grooved) can be ordered through Quick Response Department.  
 Inch sizes 1, 2, and 3 and metric sizes 2, 3, and 4mm do not have grooves.  
 Sizes 20, 24, 32 require additional lubrication prior to assembly.

## T2HF, MAR BSPP Tube End Male Adapter For fractional tube

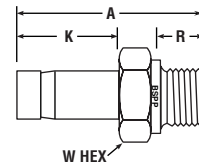
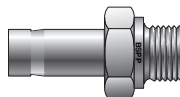

CPI™ PART NO.	A-LOK® PART NO.	INTER- CHANGES WITH	INCHES						
			TUBE O. D.	BSPP THREAD	A	K	R	W HEX	BORE
2-2R T2HF	2MA2R	2TA-1-2RS	1/8	1/8	1.09	.53	.28	9/16	.05
2-4R T2HF	2MA4R	2TA-1-4RS	1/8	1/4	1.31	.53	.44	3/4	.05
4-2R T2HF	4MA2R	4TA-1-2RS	1/4	1/8	1.19	.63	.28	9/16	.16
4-4R T2HF	4MA4R	4TA-1-4RS	1/4	1/4	1.50	.63	.44	3/4	.18
6-2R T2HF	6MA2R	6TA-1-2RS	3/8	1/8	1.34	.69	.28	3/4	.05
6-4R T2HF	6MA4R	6TA-1-4RS	3/8	1/4	1.47	.69	.44	3/4	.25
6-6R T2HF	6MA6R	6TA-1-6RS	3/8	3/8	1.50	.69	.44	7/8	.28
6-8R T2HF	6MA8R	6TA-1-8RS	3/8	1/2	1.69	.69	.56	1-1/16	.28
8-4R T2HF	8MA4R	8TA-1-4RS	1/2	1/4	1.69	.91	.44	3/4	.25
8-6R T2HF	8MA6R	8TA-1-6RS	1/2	3/8	1.72	.91	.44	7/8	.31
8-8R T2HF	8MA8R	8TA-1-8RS	1/2	1/2	1.94	.91	.56	1-1/16	.39
10-8R T2HF	10MA8R	10TA-1-8RS	5/8	1/2	1.97	.97	.56	1-1/16	.47
12-12R T2HF	12MA12R	12TA-1-12RS	3/4	3/4	2.09	.97	.63	1-5/16	.578
16-16R T2HF	16MA16R	16TA-1-16RS	1	1	2.53	1.22	.72	1-5/8	.80

**NOTE:** Add -Z6 for assembly of nuts and ferrules on the tube stub end. Dimensions for reference only, subject to change.  
 Tube stub is pre-grooved as standard. Generic (non-grooved) can be ordered through Quick Response Department.  
 Bonded sealing washer must be used with this design, see p.72.

**T2HF, MAR**  
**BSPP Tube End**  
**Male Adapter**  
*For metric tube*

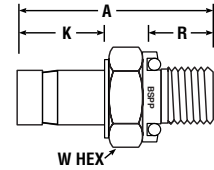
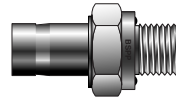

CPI™ PART NO.	A-LOK® PART NO.	INTER- CHANGES WITH	MILLIMETERS									
			TUBE O.D.	BSPP THREAD	A	K	Q	R	X	W HEX	BORE	
T2HF 3-1/8R	M3MA1/8R	3-MTA-1-2RS	3	1/8	31,0	13,5	0,6	7,1	13,7	14,0	1,8	
T2HF 4-1/8R	M4MA1/8R	4-MTA-1-2RS	4	1/8	31,8	14,3	1,0	7,1	13,7	14,0	2,0	
T2HF 6-1/8R	M6MA1/8R	6-MTA-1-2RS	6	1/8	33,3	15,9	1,0	7,1	13,7	14,0	4,0	
T2HF 6-1/4R	M6MA1/4R	6-MTA-1-4RS	6	1/4	38,1	15,9	1,0	11,2	17,8	19,0	4,0	
T2HF 8-1/4R	M8MA1/4R	8-MTA-1-4RS	8	1/4	38,9	16,7	0,8	11,2	17,8	19,0	6,4	
T2HF 10-1/4R	M10MA1/4R	10-MTA-1-4RS	10	1/4	39,7	17,5	1,3	11,2	17,8	19,0	6,4	
T2HF 10-3/8R	M10MA3/8R	10-MTA-1-6RS	10	3/8	38,9	17,5	1,3	11,2	21,8	22,0	7,5	
T2HF 10-1/2R	M10MA1/2R	10-MTA-1-8RS	10	1/2	42,9	17,5	1,3	14,2	25,7	27,0	7,5	
T2HF 12-1/4R	M12MA1/4R	12-MTA-1-4RS	12	1/4	43,7	23,0	1,4	11,2	17,8	19,0	6,4	
T2HF 12-3/8R	M12MA3/8R	12-MTA-1-6RS	12	3/8	44,5	23,0	1,4	11,2	21,8	22,0	7,9	
T2HF 12-1/2R	M12MA1/2R	12-MTA-1-8RS	12	1/2	49,2	23,0	1,4	14,2	25,7	27,0	9,1	
T2HF 16-1/2R	M16MA1/2R	16-MTA-1-8RS	16	1/2	50,8	24,6	1,7	14,2	25,7	27,0	11,9	
T2HF 18-3/4R	M18MA3/4R	18-MTA-1-12RS	18	3/4	53,2	24,6	2,0	16,0	31,8	33,0	14,0	
T2HF 20-3/4R	M20MA3/4R	20-MTA-1-12RS	20	3/4	54,0	25,4	2,5	16,0	31,8	33,0	15,1	
T2HF 25-1R	M25MA1R	25-MTA-1-16RS	25	1	65,1	31,8	2,6	18,3	38,6	41,0	19,8	

**NOTE:** Tube stub is pre-grooved as standard. Generic (non-grooved) can be ordered through Quick Response Department.  
 Bonded sealing washer must be used with this design, see p. 72. Dimensions for reference only, subject to change.  
 Add -Z6 for assembly of nuts and ferrules on the tube stub end.

**T2HF, MAR**  
**BSPP Tube End Male**  
**Adapter with ED Seal**  
*For fractional tube*

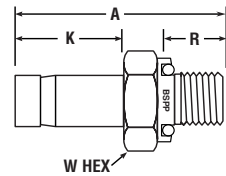
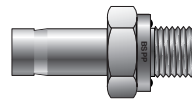

CPI™ PART NO.	A-LOK® PART NO.	INTER- CHANGES WITH	INCHES							
			TUBE O.D.	BSPP THREAD	A	K	R	X	W HEX	BORE
4-4R-ED T2HF	4MA4R-ED	—	1/4	1/4	1.50	.63	.47	.74	3/4	.18
4-6R-ED T2HF	4MA6R-ED	—	1/4	3/8	1.50	.63	.47	.86	3/4	.18
8-4R-ED T2HF	8MA4R-ED	—	1/2	1/4	1.75	.91	.47	.74	3/4	.25
8-6R-ED T2HF	8MA6R-ED	—	1/2	3/8	1.78	.91	.47	.86	7/8	.31
8-8R-ED T2HF	8MA8R-ED	—	1/2	1/2	1.94	.91	.55	1.04	1.1/16	.39

**NOTE:** Tube stub is pre-grooved as standard. Generic (non-grooved) can be ordered through Quick Response Department.  
 ED fittings are supplied with sealing washers in nitrile as standard, suitable for temperatures between -35°C and +100°C (-31°F to +212°F). Fluorocarbon seals are available upon request which are suitable for temperatures between -25°C and +120°C (13°F to +248°F). Dimensions for reference only, subject to change.  
 Add -Z6 for assembly of nuts and ferrules on the tube stub end.

**Color Coding**

For easy reference, table heads are color indicated as follows:

**fractional**



**metric**



## T2HF, MAR BSPP Tube End Male Adapter with ED Seal For metric tube

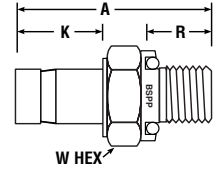

CPI™ PART NO.	A-LOK® PART NO.	INTER- CHANGES WITH	MILLIMETERS						
			TUBE O.D.	BSPP THREAD	A	K	R	W HEX	BORE
T2HF 6-1/4R-ED	M6MA1/4R-ED	—	6	1/4	36,6	15,9	7,9	19,0	4,0
T2HF 6-1/2R-ED	M6MA1/2R-ED	—	6	1/2	42,7	15,9	14,0	27,0	4,0
T2HF 10-1/4R-ED	M10MA1/4R-ED	—	10	1/4	38,1	17,5	11,9	19,0	6,4
T2HF 10-1/2R-ED	M10MA1/2R-ED	—	10	1/2	44,2	17,5	14,0	27,0	7,5
T2HF 12-1/4R-ED	M12MA1/4R-ED	—	12	1/4	43,7	23,0	11,9	19,0	6,4
T2HF 12-3/8R-ED	M12MA3/8R-ED	—	12	3/8	45,0	23,0	11,9	22,0	7,9
T2HF 12-1/2R-ED	M12MA1/2R-ED	—	12	1/2	49,8	23,0	14,0	27,0	9,1

**NOTE:** Tube stub is pre-grooved as standard. Generic (non-grooved) can be ordered through Quick Response Department.

ED fittings are supplied with sealing washers in nitrile as standard, suitable for temperatures between -35°C and +100°C (-31°F to +212°F). Fluorocarbon seals are available upon request which are suitable for temperatures between -25°C and +120°C (13°F to +248°F).

Dimensions for reference only, subject to change.

Add -Z6 for assembly of nuts and ferrules on the tube stub end.

## T2HF, MAN NPT Male Adapter For metric tube

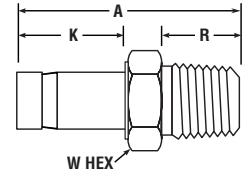
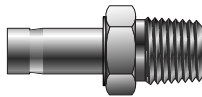

CPI™ PART NO.	A-LOK® PART NO.	INTER- CHANGES WITH	MILLIMETERS						
			TUBE O.D.	NPT THREAD	A	K	R	W HEX	BORE
T2HF 3-1/8	M3MA1/8N	3-MTA-1-2	3	1/8	29,4	13,5	9,7	12,0	1,8
T2HF 4-1/8	M4MA1/8N	4-MTA-1-2	4	1/8	29,4	14,3	9,7	12,0	2,0
T2HF 6-1/8	M6MA1/8N	6-MTA-1-2	6	1/8	31,0	15,9	9,7	12,0	4,0
T2HF 6-1/4	M6MA1/4N	6-MTA-1-4	6	1/4	35,7	15,9	14,2	14,0	4,0
T2HF 6-3/8	M6MA3/8N	6-MTA-1-6	6	3/8	36,5	16,1	14,2	18,0	3,0
T2HF 6-1/2	M6MA1/2N	6-MTA-1-8	6	1/2	42,1	16,1	19,1	22,0	3,0
T2HF 8-1/4	M8MA1/4N	8-MTA-1-4	8	1/4	37,3	16,7	14,2	14,0	6,4
T2HF 8-3/8	M8MA3/8N	8-MTA-1-6	8	3/8	38,1	16,7	14,2	12,0	6,4
T2HF 10-1/4	M10MA1/4N	10-MTA-1-4	10	1/4	38,1	17,5	14,2	14,0	7,1
T2HF 10-3/8	M10MA3/8N	10-MTA-1-6	10	3/8	43,7	17,5	14,2	18,0	7,5
T2HF 10-1/2	M10MA1/2N	10-MTA-1-8	10	1/2	44,5	17,5	19,1	22,0	7,5
T2HF 12-1/4	M12MA1/4N	12-MTA-1-4	12	1/4	43,7	23,0	14,2	14,0	7,1
T2HF 12-3/8	M12MA3/8N	12-MTA-1-6	12	3/8	44,5	23,0	14,2	27,0	9,1
T2HF 12-1/2	M12MA1/2N	12-MTA-1-8	12	1/2	49,2	23,0	19,1	22,0	9,1
T2HF 16-1/2	M16MA1/2N	16-MTA-1-8	16	1/2	50,8	24,6	19,1	22,0	12,7
T2HF 16-3/4	M16MA3/4N	16-MTA-1-12	16	3/4	51,6	24,6	19,1	27,0	12,7
T2HF 18-1/2	M18MA1/2N	18-MTA-1-8	18	1/2	50,8	24,6	19,1	22,0	12,7
T2HF 18-3/4	M18MA3/4N	18-MTA-1-12	18	3/4	51,6	24,6	19,1	27,0	14,0
T2HF 20-1/2	M20MA1/2N	20-MTA-1-8	20	1/2	51,8	25,6	19,1	22,0	15,0
T2HF 20-3/4	M20MA3/4N	20-MTA-1-12	20	3/4	52,4	25,4	19,1	27,0	15,1
T2HF 25-1	M25MA1N	25-MTA-1-16	25	1	65,9	31,8	23,9	35,0	19,8

**NOTE:** Tube stub is pre-grooved as standard. Generic (non-grooved) can be ordered through Quick Response Department.

Dimensions for reference only, subject to change.

Add -Z6 for assembly of nuts and ferrules on the tube stub end.

## Color Coding

For easy reference, table heads are color indicated as follows:

**fractional**

**metric**





## T2HF, MAK BSP Taper Male Adapter For fractional tube

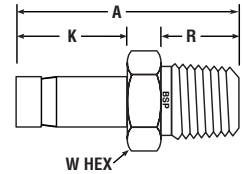
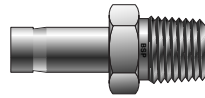

CPI™ PART NO.	A-LOK® PART NO.	INTER- CHANGES WITH	INCHES						
			TUBE O.D.	BSPT THREAD	A	K	R	W HEX	BORE
4-2K T2HF	4MA2K	4-TA-1-2RT	1/4	1/8	1.25	.63	.38	7/16	.156
4-4K T2HF	4MA4K	4-TA-1-4RT	1/4	1/4	1.46	.63	.56	9/16	.156
4-6K T2HF	4MA6K	4-TA-1-6RT	1/4	3/8	1.44	.63	.56	11/16	.156
4-8K T2HF	4MA8K	4-TA-1-8RT	1/4	1/2	1.66	.63	.75	7/8	.219
5-2 T2HF	5MA2K	5-TA-1-2RT	5/16	1/8	1.29	.66	.38	7/16	.219
5-4 T2HF	5MA4K	5-TA-1-4RT	5/16	1/4	1.50	.66	.56	9/16	.219
6-4 T2HF	6MA4K	6-TA-1-4RT	3/8	1/4	1.50	.69	.56	9/16	.281
6-6 T2HF	6MA6K	6-TA-1-6RT	3/8	3/8	1.50	.69	.56	11/16	.281
6-8 T2HF	6MA8K	6-TA-1-8RT	3/8	1/2	1.72	.69	.75	7/8	.281
8-4 T2HF	8MA4K	8-TA-1-4RT	1/2	1/4	1.72	.91	.56	9/16	.375
8-6 T2HF	8MA6K	8-TA-1-6RT	1/2	3/8	1.75	.91	.56	11/16	.375
8-8 T2HF	8MA8K	8-TA-1-8RT	1/2	1/2	1.94	.91	.75	7/8	.375
10-8 T2HF	10MA8K	10-TA-1-8RT	5/8	1/2	2.06	.97	.75	7/8	.469

**NOTE:** Tube stub is pre-grooved as standard. Generic (non-grooved) can be ordered through Quick Response Department.  
Add -Z6 for assembly of nuts and ferrules on the tube stub end.

Dimensions for reference only, subject to change.

## T2HF, MAK BSP Taper Male Adapter For metric tube

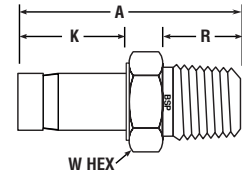
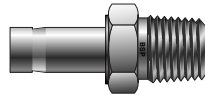

CPI™ PART NO.	A-LOK® PART NO.	INTER- CHANGES WITH	MILLIMETERS						
			TUBE O.D.	BSPT THREAD	A	K	R	W HEX	BORE
T2HF 3-1/8K	M3MA1/8K	3-MTA-1-2RT	3	1/8	29,4	13,5	9,7	12,0	1,8
T2HF 4-1/8K	M4MA1/8K	4-MTA-1-2RT	4	1/8	29,4	14,3	9,7	12,0	2,0
T2HF 6-1/8K	M6MA1/8K	6-MTA-1-2RT	6	1/8	31,0	15,9	9,7	12,0	4,0
T2HF 6-1/4K	M6MA1/4K	6-MTA-1-4RT	6	1/4	35,7	15,9	14,2	14,0	4,0
T2HF 8-1/4K	M8MA1/4K	8-MTA-1-4RT	8	1/4	37,3	16,7	14,2	14,0	6,4
T2HF 8-3/8K	M8MA3/8K	8-MTA-1-6RT	8	3/8	38,3	16,8	14,2	18,0	5,0
T2HF 10-1/4K	M10MA1/4K	10-MTA-1-4RT	10	1/4	38,1	17,5	14,2	14,0	7,1
T2HF 10-3/8K	M10MA3/8K	10-MTA-1-6RT	10	3/8	38,1	17,5	14,2	18,0	7,5
T2HF 10-1/2K	M10MA1/2K	10-MTA-1-8RT	10	1/2	44,5	17,5	19,1	22,0	7,5
T2HF 12-1/4K	M12MA1/4K	12-MTA-1-4RT	12	1/4	43,7	23,0	14,2	14,0	7,1
T2HF 12-3/8K	M12MA3/8K	12-MTA-1-6RT	12	3/8	44,5	23,0	14,2	18,0	9,1
T2HF 12-1/2K	M12MA1/2K	12-MTA-1-8RT	12	1/2	49,2	23,0	19,1	22,0	9,1
T2HF 16-1/2K	M16MA1/2K	16-MTA-1-8RT	16	1/2	50,8	24,6	19,1	22,0	12,7
T2HF 18-3/4K	M18MA3/4K	18-MTA-1-12RT	18	3/4	51,6	24,6	19,1	27,0	14,0
T2HF 20-3/4K	M20MA3/4K	20-MTA-1-12RT	20	3/4	52,4	25,4	19,1	27,0	15,1
T2H 25-1K	M25MA1K	25-MTA-1-16RT	25	1	65,9	31,8	23,9	35,0	19,8

**NOTE:** Tube stub is pre-grooved as standard. Generic (non-grooved) can be ordered through Quick Response Department.  
Add -Z6 for assembly of nuts and ferrules on the tube stub end.

Dimensions for reference only, subject to change.

## T2HOA, TUHA Tube End to SAE Straight Thread Adapter For fractional tube

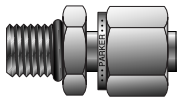
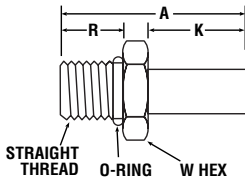
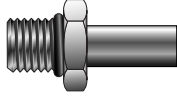

CPI™ PART NO.	A-LOK® PART NO.	INTER- CHANGES WITH	INCHES						O-RING APR UNIFORM DASH NO.
			T TUBE O. D.	STRAIGHT THREAD SIZE	A	K	R	W HEX	
6-4 T2HOA	6TUHOA4	6-TA-1-4ST	3/8	7/16-20	1.46	.69	.36	9/16	3-904
6-8 T2HOA	6TUHOA8	6-TA-1-8ST	3/8	3/4-16	1.59	.69	.44	7/8	3-908
8-6 T2HOA	8TUHOA6	8-TA-1-6ST	1/2	9/16-18	1.74	.91	.39	11/16	3-906
10-10 T2HOA	10TUHOA10	10-TA-1-10ST	5/8	7/8-14	1.94	.91	.50	1	3-910
*24-24 T2HOA	24TUHOA24	24-TA-1-24ST	1-1/2	1-7/8-12	3.28	2.05	.59	2-1/8	3-924

\* Sizes 20, 24 and 32 are preassembled with nut and ferrules. Dimensions for reference only, subject to change.  
A dimension is typical finger-tight.  
Size 24 requires additional lubrication prior to assembly.  
Parts are supplied with nitrile o-rings as standard. For Fluorocarbon o-rings, add the suffix "-VO".  
Other o-rings available upon request.

Add -Z6 for assembly of nuts and ferrules on the tube stub end.

## T2HG, FAN Tube End NPT Female Adapter For fractional tube

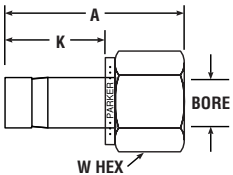
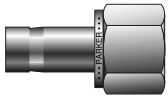

CPI™ PART NO.	A-LOK® PART NO.	INTER- CHANGES WITH	INCHES					
			TUBE O. D.	NPT PIPE THREAD	A	K	W HEX	BORE
1-2 T2HG	1FA2N	1-TA-7-2	1/16	1/8	1.07	.34	9/16	.031
2-2 T2HG	2FA2N	2-TA-7-2	1/8	1/8	1.23	.53	9/16	.093
2-4 T2HG	2FA4N	2-TA-7-4	1/8	1/4	1.38	.53	3/4	.093
3-2 T2HG	3FA2N	3-TA-7-2	3/16	1/8	1.25	.56	9/16	.116
3-4 T2HG	3FA4N	3-TA-7-4	3/16	1/4	1.42	.56	3/4	.116
4-2 T2HG	4FA2N	4-TA-7-2	1/4	1/8	1.31	.63	9/16	.188
4-4 T2HG	4FA4N	4-TA-7-4	1/4	1/4	1.47	.63	3/4	.188
4-6 T2HG	4FA6N	4-TA-7-6	1/4	3/8	1.56	.63	7/8	.188
4-8 T2HG	4FA8N	4-TA-7-8	1/4	1/2	1.80	.63	1-1/16	.188
5-2 T2HG	5FA2N	5-TA-7-2	5/16	1/8	1.34	.66	9/16	.219
5-4 T2HG	5FA4N	5-TA-7-4	5/16	1/4	1.50	.66	3/4	.219
5-6 T2HG	5FA6N	5-TA-7-6	5/16	3/8	1.59	.66	7/8	.219
6-2 T2HG	6FA2N	6-TA-7-2	3/8	1/8	1.36	.69	9/16	.281
6-4 T2HG	6FA4N	6-TA-7-4	3/8	1/4	1.55	.69	3/4	.281
6-6 T2HG	6FA6N	6-TA-7-6	3/8	3/8	1.59	.69	7/8	.281
6-8 T2HG	6FA8N	6-TA-7-8	3/8	1/2	1.84	.69	1-1/16	.281
8-4 T2HG	8FA4N	8-TA-7-4	1/2	1/4	1.72	.91	3/4	.391
8-6 T2HG	8FA6N	8-TA-7-6	1/2	3/8	1.80	.91	7/8	.391
8-8 T2HG	8FA8N	8-TA-7-8	1/2	1/2	2.10	.91	1-1/16	.390
10-6 T2HG	10FA6N	10-TA-7-6	5/8	3/8	1.86	.97	7/8	.469
10-8 T2HG	10FA8N	10-TA-7-8	5/8	1/2	2.09	.97	1-1/16	.469
12-8 T2HG	12FA8N	12-TA-7-8	3/4	1/2	2.10	.97	1-1/16	.578
12-12 T2HG	12FA12N	12-TA-7-12	3/4	3/4	2.16	.97	1-1/4	.578
12-16 T2HG	12FA16N	12-TA-7-16	3/4	1	2.30	.97	1-5/8	.578
14-12 T2HG	14FA12N	14-TA-7-12	7/8	3/4	2.22	1.02	1-5/16	.578
16-12 T2HG	16FA12N	16-TA-7-12	1	3/4	2.41	1.22	1-5/16	.813
16-16 T2HG	16FA16N	16-TA-7-16	1	1	2.54	1.22	1-5/8	.813
20-20 T2HG	20FA20N	20-TA-7-20	1-1/4	1-1/4	3.06	1.71	2-1/8	1.000
24-24 T2HG	24FA24N	24-TA-7-24	1-1/2	1-1/2	3.50	2.05	2-3/8	1.250
32-32 T2HG	32FA32N	32-TA-7-32	2	2	4.23	2.74	2-7/8	1.720

NOTE: Tube stub is pre-grooved as standard. Dimensions for reference only, subject to change.  
Generic (non-grooved) can be ordered through Quick Response Department.  
Add -Z6 for assembly of nuts and ferrules on the tube stub end.

## Color Coding

For easy reference, table heads are color indicated as follows:

fractional

metric



## T2HG, FAN Tube End NPT Female Adapter For metric tube

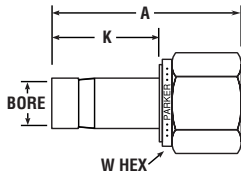
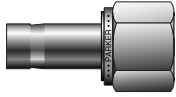

CPI™ PART NO.	A-LOK® PART NO.	INTER- CHANGES WITH	MILLIMETERS					
			TUBE O. D.	NPT THREAD	A	K	W HEX	BORE
T2HG 3-1/8	M3FA1/8N	3-MTA-7-2	3	1/8	31,3	13,5	14,0	1,3
T2HG 4-1/8	M4FA1/8N	4-MTA-7-2	4	1/8	29,4	14,3	14,0	2,0
T2HG 6-1/8	M6FA1/8N	6-MTA-7-2	6	1/8	29,4	15,9	14,0	4,0
T2HG 6-1/4	M6FA1/4N	6-MTA-7-4	6	1/4	34,1	15,9	19,0	4,0
T2HG 8-1/8	M8FA1/8N	8-MTA-7-2	8	1/8	35,5	16,7	14,0	6,4
T2HG 8-1/4	M8FA1/4N	8-MTA-7-4	8	1/4	35,1	16,7	19,0	6,4
T2HG 8-3/8	M8FA3/8N	8-MTA-7-6	8	3/8	36,5	16,7	22,0	6,4
T2HG 10-1/4	M10FA1/4N	10-MTA-7-4	10	1/4	37,3	17,5	19,0	7,5
T2HG 10-3/8	M10FA3/8N	10-MTA-7-6	10	3/8	37,3	17,5	22,0	7,5
T2HG 10-1/2	M10FA1/2N	10-MTA-7-8	10	1/2	42,1	17,5	27,0	7,5
T2HG 12-1/4	M12FA1/4N	12-MTA-7-4	12	1/4	41,3	23,0	19,0	9,1
T2HG 12-3/8	M12FA3/8N	12-MTA-7-6	12	3/8	42,9	23,0	22,0	9,1
T2HG 12-1/2	M12FA1/2N	12-MTA-7-8	12	1/2	47,6	23,0	27,0	9,1
T2HG 16-1/2	M16FA1/2N	16-MTA-7-8	16	1/2	49,2	24,6	27,0	12,7
T2HG 18-3/4	M18FA3/4N	18-MTA-7-12	18	3/4	52,4	24,6	33,0	14,0
T2HG 20-1/2	M20FA1/2N	20-MTA-7-8	20	1/2	50,0	25,6	27,0	15,0
T2HG 20-3/4	M20FA3/4N	20-MTA-7-12	20	3/4	53,2	25,4	33,0	15,1
T2G 25-1	M25FA1N	25-MTA-7-16	25	1	66,7	31,8	41,0	19,8

**NOTE:** Tube stub is pre-grooved as standard.

Dimensions for reference only, subject to change.

Generic (non-grooved) can be ordered through Quick Response Department.

Add -Z6 for assembly of nuts and ferrules on the tube stub end.

## T2HG, FAK BSP Taper Female Adapter For fractional tube

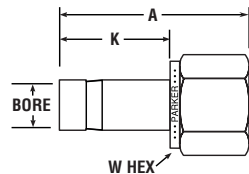
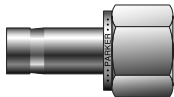

CPI™ PART NO.	A-LOK® PART NO.	INTER- CHANGES WITH	INCHES					
			TUBE O. D.	BSPT THREAD	A	K	W HEX	BORE
4-2K T2HG	4FA2K	4-TR-7-2RT	1/4	1/8-28	1.31	.64	9/16	.156
4-4K T2HG	4FA4K	4-TR-7-4RT	1/4	1/4-19	1.48	.64	3/4	.156
6-4K T2HG	6FA4K	6-TR-7-4RT	3/8	1/4-19	1.56	.72	3/4	.281
6-6K T2HG	6FA6K	6-TR-7-6RT	3/8	3/8-19	1.63	.72	7/8	.281
8-4K T2HG	8FA4K	8-TR-7-4RT	1/2	1/4-19	1.83	.98	3/4	.375
8-6K T2HG	8FA6K	8-TR-7-6RT	1/2	3/8-19	1.89	.98	7/8	.375
8-8K T2HG	8FA8K	8-TR-7-8RT	1/2	1/2-14	2.14	.98	1-1/16	.375

**NOTE:** Tube stub is pre-grooved as standard.

Dimensions for reference only, subject to change.

Generic (non-grooved) can be ordered through Quick Response Department.

Add -Z6 for assembly of nuts and ferrules on the tube stub end.

## T2HG, FAK BSP Taper Female Adapter For metric tube

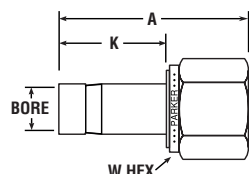
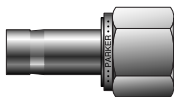

CPI™ PART NO.	A-LOK® PART NO.	INTER- CHANGES WITH	MILLIMETERS					
			TUBE O. D.	BSPT THREAD	A	K	W HEX	BORE
T2HG 3-1/8K	M3FA1/8K	3-MTA-7-2RT	3	1/8	27,8	13,5	14,0	1,8
T2HG 4-1/8K	M4FA1/8K	4-MTA-7-2RT	4	1/8	28,6	14,3	14,0	2,0
T2HG 6-1/8K	M6FA1/8K	6-MTA-7-2RT	6	1/8	30,2	15,9	14,0	4,0
T2HG 8-1/4K	M8FA1/4K	8-MTA-7-4RT	8	1/4	39,1	16,7	19,0	6,4
T2HG 10-1/4K	M10FA1/4K	10-MTA-7-4RT	10	1/4	36,5	17,5	19,0	7,5
T2HG 10-3/8K	M10FA3/8K	10-MTA-7-6RT	10	3/8	31,8	17,5	22,0	7,5
T2HG 10-1/2K	M10FA1/2K	10-MTA-7-8RT	10	1/2	41,3	17,5	27,0	7,5
T2HG 12-1/4K	M12FA1/4K	12-MTA-7-4RT	12	1/4	40,5	23,0	19,0	9,1
T2HG 12-3/8K	M12FA3/8K	12-MTA-7-6RT	12	3/8	43,7	23,0	22,0	9,1
T2HG 12-1/2K	M12FA1/2K	12-MTA-7-8RT	12	1/2	46,8	23,0	27,0	9,1
T2HG 16-1/2K	M16FA1/2K	16-MTA-7-8RT	16	1/2	48,4	24,6	27,0	12,7
T2HG 18-3/4K	M18FA3/4K	18-MTA-7-12RT	18	3/4	51,6	24,6	32,0	14,0
T2HG 20-3/4K	M20FA3/4K	20-MTA-7-12RT	20	3/4	52,4	25,4	32,0	15,1
T2HG 25-1K	M25FA1K	25-MTA-7-16RT	25	1	66,7	31,8	41,0	19,8

**4-NOTE:** Tube stub is pre-grooved as standard.

Dimensions for reference only, subject to change.

Add -Z6 for assembly of nuts and ferrules on the tube stub end.

## T2HG, FAR BSPP Female Adapter For fractional tube

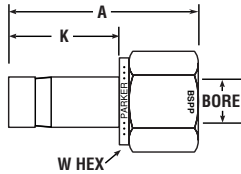
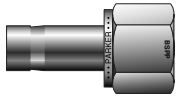

CPI™ PART NO.	A-LOK® PART NO.	INTER- CHANGES WITH	INCHES					
			TUBE O.D.	BSPP THREAD	A	K	W HEX	BORE
4-4R T2HG	4FA4R	4-TA-7-4RP	1/4	1/4	1.47	.63	3/4	.18
6-6R T2HG	6FA6R	6-TA-7-6RP	3/8	3/8	1.53	.69	7/8	.28
8-8R T2HG	8FA8R	8-TA-7-8RP	1/2	1/2	1.91	.91	1-1/16	.39

**NOTE:** Copper washer must be used for this design.

Dimensions for reference only, subject to change.

Tube stub is pre-grooved as standard. Generic (non-grooved) can be ordered through Quick Response Department.  
Add -Z6 for assembly of nuts and ferrules on the tube stub end.

## T2HG, FAR BSPP Female Adapter For metric tube

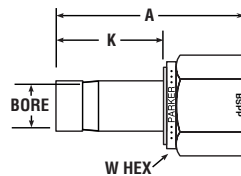
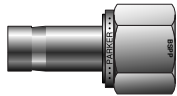

CPI™ PART NO.	A-LOK® PART NO.	INTER- CHANGES WITH	MILLIMETERS					
			TUBE O.D.	BSPP THREAD	A	K	W HEX	BORE
T2HG 3-1/8R	M3FA1/8R	3-MTA-7-2RP	3	1/8	28,6	13,5	14,0	1,8
T2HG 3-1/4R	M3FA1/4R	3-MTA-7-4RP	3	1/4	28,6	13,7	19,0	1,6
T2HG 4-1/8R	M4FA1/8R	4-MTA-7-2RP	4	1/8	29,4	14,3	14,0	2,0
T2HG 6-1/8R	M6FA1/8R	6-MTA-7-4RP	6	1/8	31,0	15,9	14,0	4,0
T2HG 6-1/4R	M6FA1/4R	6-MTA-7-4RP	6	1/4	37,3	15,9	19,0	4,0
T2HG 8-1/4R	M8FA1/4R	8-MTA-7-4RP	8	1/4	38,1	16,7	19,0	6,4
T2HG 10-1/4R	M10FA1/4R	10-MTA-7-4RP	10	1/4	38,9	17,5	19,0	7,5
T2HG 10-1/2R	M10FA1/2R	10-MTA-7-8RP	10	1/2	43,7	17,5	27,0	7,5
T2HG 12-3/8R	M12FA3/8R	12-MTA-7-6RP	12	3/8	44,5	23,0	22,0	9,1
T2HG 12-1/2R	M12FA1/2R	12-MTA-7-8RP	12	1/2	48,4	23,0	27,0	9,1
T2HG 16-1/2R	M16FA1/2R	16-MTA-7-8RP	16	1/2	50,0	24,6	27,0	12,7
T2HG 18-3/4R	M18FA3/4R	18-MTA-7-12RP	18	3/4	53,2	24,6	33,0	14,0
T2HG 20-3/4R	M20FA3/4R	20-MTA-7-12RP	20	3/4	54,0	25,4	33,0	15,1
T2HG 25-1R	M25FA1R	25-MTA-7-16RP	25	1	67,5	31,8	41,0	19,8

**NOTE:** Copper washer must be used for this design.

Dimensions for reference only, subject to change.

Tube stub is pre-grooved as standard. Generic (non-grooved) can be ordered through Quick Response Department.  
Add -Z6 for assembly of nuts and ferrules on the tube stub end.

## P2T2, P2TU Push-Lok to Tube Adapter For fractional tube

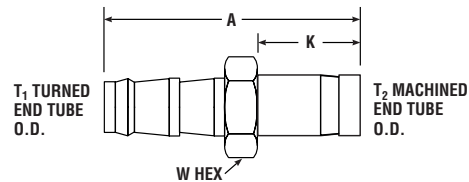
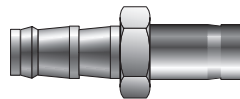

CPI™ PART NO.	A-LOK® PART NO.	INTER- CHANGES WITH	INCHES				
			T <sub>1</sub> TUBE O.D.	T <sub>2</sub> HOSE SIZE	A	K	W HEX
4-4 P2T2	4P2TU4	PB4-TA4	1/4	-4	1.80	.64	7/16
6-6 P2T2	6P2TU6	PB6-TA6	3/8	-6	2.02	.72	9/16
8-8 P2T2	8P2TU8	PB8-TA8	1/2	-8	2.42	.98	11/16

**NOTE:** Drawing does not show Push-Lok collar.

Dimensions for reference only, subject to change.

Tube stub is pre-grooved as standard. Generic (non-grooved) can be ordered through Quick Response Department.  
Add -Z6 for assembly of nuts and ferrules on the tube stub end.

## Color Coding

For easy reference, table heads are color indicated as follows:

**fractional**



**metric**

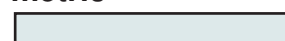

## P2HF Push-Lok to Male Adapter For fractional tube

CPI™ PART NO.	A-LOK® PART NO.	INTER- CHANGES WITH	INCHES					
			T <sub>2</sub> NPT PIPE THREAD	T <sub>1</sub> HOSE SIZE	A	B	R	W HEX
4-4 P2HF	4-4 P2HF	PB4-PM4	1/4	-4	1.65	.80	.56	9/16
6-6 P2HF	6-6 P2HF	PB6-PM6	3/8	-6	1.828	.95	.56	11/16
8-8 P2HF	8-8 P2HF	PB8-PM8	1/2	-8	2.194	1.10	.75	7/8

NOTE: Drawing does not show Push-Lok collar.

Dimensions for reference only, subject to change.

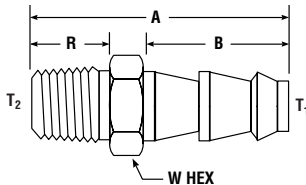
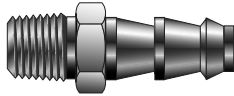

## P2BZ6, P2LZ6 Push-Lok to CPI™/A-LOK® For fractional tube

CPI™ PART NO.	A-LOK® PART NO.	INTER- CHANGES WITH	INCHES				
			T <sub>2</sub> TUBE O.D.	T <sub>1</sub> HOSE SIZE	A	K	W HEX
4-4 P2BZ6	4-4 P2LZ6	PB4-TA4	1/4	-4	1.77	.72	7/16
6-6 P2BZ6	6-6 P2LZ6	PB6-TA6	3/8	-6	1.98	.78	9/16
8-8 P2BZ6	8-8 P2LZ6	PB8-TA8	1/2	-8	2.42	1.03	11/16

NOTE: A dimension is typical finger-tight.

Dimensions for reference only, subject to change.

Drawing does not show Push-Lok collar. Assembly includes nut and ferrules.

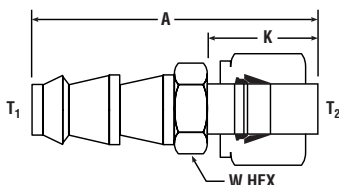
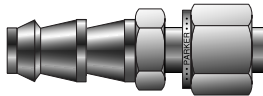

## ZPB2, ZPC2 Push-Lok to Port Connector For fractional tube

CPI™ PART NO.	A-LOK® PART NO.	INCHES			
		T <sub>1</sub> HOSE SIZE	T <sub>2</sub> PORT SIZE	A	B
4-6 ZPB2	4-6 ZPC2	-4	3/8	1.40	.80

NOTE: Drawing does not show Push-Lok collar and size 6 A-LOK® nut.

Dimensions for reference only, subject to change.

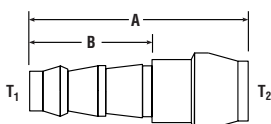
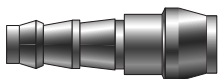

## LJFBZ, LJF Lapped Joint Tube Adapters For metric tube

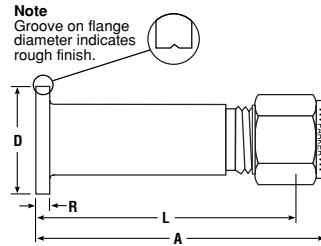
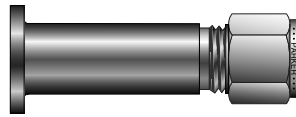

CPI™ PART NO.	A-LOK® PART NO.	INTER- CHANGES WITH	MILLIMETERS						SURFACE FINISH
			TUBE O.D.	FLANGE SIZE	A	D	L	R	
LJFBZ10-5	M10LJF-5	10M0-1-0005	10	DN15(1/2"NB)	83,0	34,5	75,5	6,5	Smooth 3,2-6,3 Ra
LJFBZ10-9	M10LJF-9	10M0-1-0006	10	DN15(1/2"NB)	83,0	34,5	75,5	6,5	Rough 6,3-12,5 Ra
LJFBZ12-5	M12LJF-5	—	12	DN15(1/2"NB)	85,0	34,5	75,4	6,5	Smooth 3,2-6,3 Ra
LJFBZ12-9	M12LJF-9	—	12	DN15(1/2"NB)	85,0	34,5	75,4	6,5	Rough 6,3-12,5 Ra

**NOTE:** Groove on flange diameter indicates rough finish.

Dimensions for reference only, subject to change.

The lapped joint tube adaptor is a fitting designed to be used with a lap joint flange which enables a direct hook-up to the instrument tube from the process line.

The compression fitting is incorporated into the body of the adaptor thus the number of components needed for hook-up is reduced. It is therefore cost efficient as well as space saving.

The face of the fitting forms the gasket face of the flange and comes with either a smooth or serrated surface finish.

Adaptors to suit other tube and flange sizes may be furnished upon request.

## ZH2X DP Transmitter Calibration Adapters For fractional tube

Parker CPI™/A-LOK® adaptors connect directly to the bleed port of a differential pressure transmitter so that the calibration process can be simplified. Two sizes of adaptors (1/4-28 Thd., 5/16-24 Thd.) are available to fit the vent ports of Rosemount, Honeywell, and Foxboro DP transmitters. Both adaptors are available in 316SS.

TRANSMITTER TYPE	PARKER PART NO.	INTERCHANGES WITH
(1) Rosemount/Foxboro	4-2 ZH2LX-SS-D950373	SS-400-1-0253
(2) Honeywell	4-2 ZH2LX-SS-D940336	SS-400-1-0257

STRAIGHT THREAD	INCHES									
	A	B	C	D	E	F	G	H	J	HEX
(1) 5/16-24	2.32	1.00	.70	2.03	.24	.60	.25	.06	.41	1/2
(2) 1/4-28	1.75	.80	.70	1.46	.47	.60	.20	.03	—	1/2

Dimensions for reference only, subject to change.

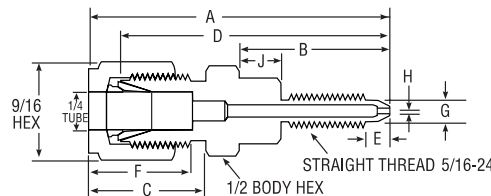
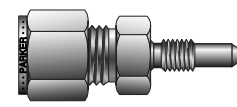
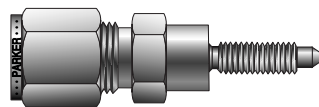

Calibration Adapter for  
Rosemount/Foxboro DP Transmitters

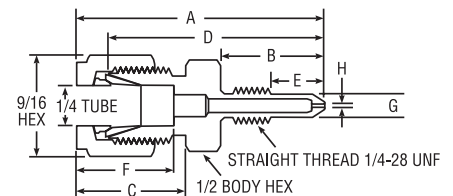

Calibration Adapter for  
Honeywell DP Transmitters

## Color Coding

For easy reference, table heads are color indicated as follows:

**fractional**

**metric**

## X6HBZ6, X6TU 37° Flare (AN) to CPI™/A-LOK® For fractional tube

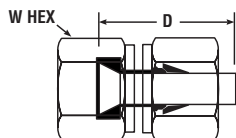

CPI™ PART NO.	A-LOK® PART NO.	INTER- CHANGES WITH	INCHES		
			TUBE O.D.	D	W HEX
2-2 X6HBZ6 4-4 X6HBZ6 6-6 X6HBZ6	2X6TU2 4X6TU4 6X6TU6	200-A-2 ANF 400-A-4 ANF 600-A-6 ANF	1/8 1/4 3/8	.88 .96 1.07	3/8 9/16 11/16
8-8 X6HBZ6 12-12 X6HBZ6 16-16 X6HBZ6	8X6TU8 12X6TU12 16X6TU16	810-A-8 ANF 1210-A-12ANF 1610-A-16ANF	1/2 3/4 1	1.37 1.49 1.80	7/8 1-1/4 1-1/2

Dimensions for reference only, subject to change.

## XHBZ, XASC 37° Flare Connector For fractional tube

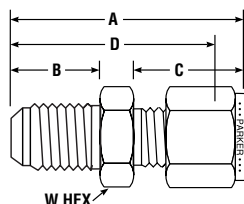
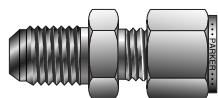

CPI™ PART NO.	A-LOK® PART NO.	INTER- CHANGES WITH	INCHES						
			FLARE END	TUBE O.D.	A	B	C	D	W HEX
2-1 XHBZ 2-2 XHBZ 4-2 XHBZ 3-3 XHBZ 4-4 XHBZ	2XASC1 2XASC2 4XASC2 3XASC3 4XASC4	100-6-2 AN 200-6-2 AN 200-6-4 AN 300-6-3 AN 400-6-4 AN	1/8 1/8 1/4 3/16 1/4	1/16 1/8 1/8 3/16 1/4	1.07 1.28 1.39 1.32 1.48	.45 .45 .55 .48 .55	.43 .60 .60 .64 .70	.92 1.02 1.13 1.06 1.19	7/16 7/16 1/2 7/16 1/2
5-5 XHBZ 4-6 XHBZ 6-6 XHBZ 8-8 XHBZ 10-10 XHBZ	5XASC5 4XASC6 6XASC6 8XASC8 10XASC10	500-6-5 AN 600-6-4 AN 600-6-6 AN 810-6-8 AN 1010-6-10 AN	5/16 1/4 3/8 1/2 5/8	5/16 3/8 3/8 1/2 5/8	1.52 1.56 1.56 1.81 1.93	.55 .55 .56 .66 .76	.73 .76 .76 .87 .87	1.22 1.27 1.27 1.41 1.53	9/16 5/8 5/8 13/16 15/16
12-12 XHBZ 16-16 XHBZ	12XASC12 16XASC16	1210-6-12 AN 1610-6-16 AN	3/4 1	3/4 1	2.11 2.43	.86 .91	.87 1.05	1.70 1.94	1-1/8 1-3/8

NOTE: A and C dimensions are typical finger-tight.

Dimensions for reference only, subject to change.

## XH2BZ, XABC 37° Flare Bulkhead Connector For fractional tube

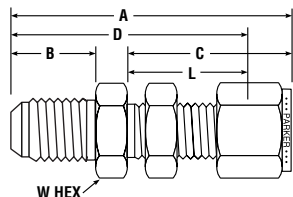
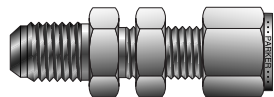

CPI™ PART NO.	A-LOK® PART NO.	INTER- CHANGES WITH	INCHES							
			FLARE END	TUBE O.D.	A	D	C	L	B	W HEX
2-2 XH2BZ 3-3 XH2BZ 4-2 XH2BZ 4-4 XH2BZ 5-5 XH2BZ	2XABC2 4XABC2 3XABC3 4XABC4 5XABC5	200-61-2 AN 200-61-4 AN 300-61-3 AN 400-61-4 AN 500-61-5 AN	1/8 1/4 3/16 1/4 5/16	1/8 1/8 3/16 1/4 5/16	1.91 2.04 1.98 2.12 2.21	1.65 1.78 1.71 1.83 1.92	1.23 1.23 1.26 1.31 1.41	.97 .97 1.00 1.02 1.12	.45 .55 .48 .55 .55	1/2 5/8 9/16 5/8 11/16
4-6 XH2BZ 6-6 XH2BZ 8-8 XH2BZ 10-10 XH2BZ 12-12 XH2BZ	4XABC6 6XABC6 8XABC8 10XABC10 12XABC12	600-61-4 AN 600-61-6 AN 810-61-8 AN 1010-61-10 AN 1210-61-12 AN	1/4 3/8 1/2 5/8 3/4	3/8 3/8 1/2 5/8 3/4	2.25 2.25 2.59 2.74 3.11	1.96 1.96 2.19 2.34 2.71	1.44 1.44 1.65 1.68 1.87	1.15 1.15 1.25 1.28 1.47	.55 .56 .66 .76 .86	3/4 3/4 15/16 1-1/16 1-3/16
16-16 XH2BZ	16XABC16	1610-61-16 AN	1	1	3.65	3.16	2.27	1.78	.91	1-9/16

NOTE: A and C dimensions are typical finger-tight.

Dimensions for reference only, subject to change.

For bulkhead hole drill size and maximum bulkhead thickness, see Page 28, Part BC

## Introduction

### BSPP / SAE Straight Thread Fittings Installation Procedure

1. Lubricate O-ring with a lubricant that is compatible with the system.
2. Screw fitting into the straight thread port until the metal back-up washer contacts the face of the port.
3. Position the fitting by backing it out *no more than one turn*.
4. Hold the fitting in position and tighten the locknut until the washer contacts the face of the port. (See torque chart.)

**NOTE:** WLN Lock Nuts are ordered separately by size and part number. Refer to page 73.

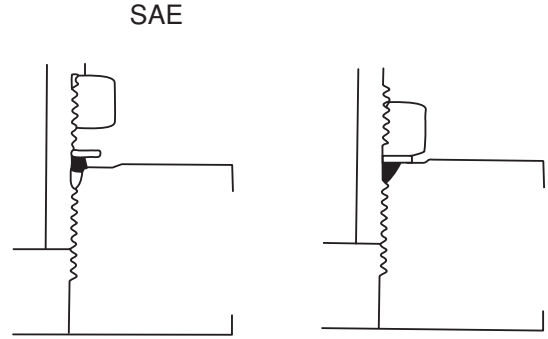
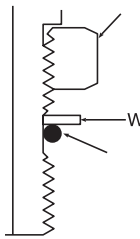

Size	Straight Port		Adjustable Port	
	Torque (in-lbs)	(F.F.F.T.)	Torque (in-lbs)	(F.F.F.T.)
4	245 ± 10	1.0 ± .25	200 ± 10	1.5 ± 25
6	630 ± 25	1.5 ± .25	400 ± 10	1.5 ± 25
8	1150 ± 50	1.5 ± .25	640 ± 10	1.5 ± 25
10	1550 ± 50	1.5 ± .25	1125 ± 50	1.5 ± 25
12	2050 ± 50	1.5 ± .25	1450 ± 50	1.5 ± 25
16	3000 ± 50	1.5 ± .25	2150 ± 50	1.5 ± 25
20	3400 ± 100	1.5 ± .25	2800 ± 100	2.0 ± 25
24	4500 ± 100	1.5 ± .25	3450 ± 100	2.0 ± 25

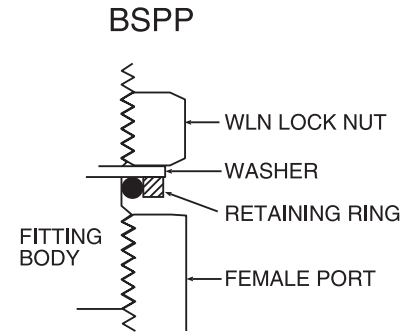

#### NOTES

- Restrain fitting body on adjustables if necessary in installation.
- Values in charts are for assemblies with O-ring lubricated.
- Use upper limits of torque ranges for stainless steel fittings.

### Face Seal O-Ring Fittings Installation Procedure

The O-ring requires a smooth, flat seating surface. This surface must be perpendicular to the axis of the threads.

1. Turn the O-ring seal fitting in the port until finger tight.
2. The “squeezing” effect on the O-ring can be felt during the last 1/4 turn.
3. Snug lightly with a wrench.

### \*Typical Application

The fitting can be adapted as a bulkhead fitting on thin wall tanks or vessels, eliminating welding, brazing or threading. Simply order the L5N locknut to take advantage of this option.

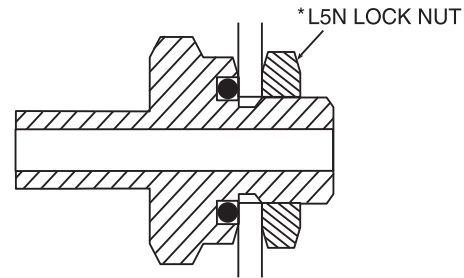

#### Notes

Standard O-rings are nitrile material. For other O-rings, state material after the part number.

L5N locknuts are ordered separately by size and part number. Refer to page 73.

PORT SIZE	STRAIGHT THREAD MACHINE LENGTH	L5N LOCKNUT THICKNESS	MAXIMUM TANK WALL THICKNESS
2	.297	.219	.078 = 5/64
3	.297	.219	.078 = 5/64
4	.360	.250	.109 = 7/65
5	.360	.250	.109 = 7/64
6	.391	.265	.125 = 1/8
8	.438	.312	.125 = 1/8
10	.500	.360	.140 = 9/64
12	.594	.406	.188 = 3/16
14	.594	.406	.188 = 3/16
16	.594	.406	.188 = 3/16

O-rings used with SAE/MS straight threads are nitrile. Other O-ring materials are available on request. Lubricate O-ring with a lubricant compatible with the system fluid, environment and O-ring material.



## ZHBA, M1SC Male Connector to SAE Straight Thread For fractional tube

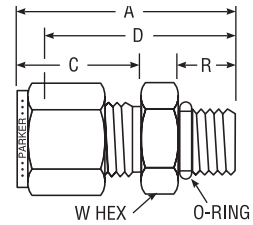
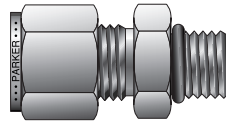

CPI™ PART NO.	A-LOK® PART NO.	INTER- CHANGES WITH	INCHES							O-RING AS UNIFORM DASH NO.
			TUBE O. D.	STRAIGHT THREAD SIZE	A	C	D	R	W HEX	
1-2 ZHBA	1M1SC2	100-1-2 ST	1/16	5/16-24	.92	.43	.77	.30	7/16	3-902
2-2 ZHBA	2M1SC2	200-1-2 ST	1/8	5/16-24	1.18	.60	.92	.30	7/16	3-902
2-6 ZHBA	2M1SC6	200-1-6 ST	1/8	9/16-18	1.35	.60	1.06	.39	11/16	3-906
3-3 ZHBA	3M1SC3	300-1-3 ST	3/16	3/8-24	1.20	.64	.94	.30	1/2	3-903
4-4 ZHBA	4M1SC4	400-1-4 ST	1/4	7/16-20	1.34	.70	1.05	.36	9/16	3-904
4-6 ZHBA	4M1SC6	400-1-6 ST	1/4	9/16-18	1.40	.70	1.11	.39	11/16	3-906
4-8 ZHBA	4M1SC8	400-1-8 ST	1/4	3/4-16	1.48	.70	1.19	.44	7/8	3-908
4-10 ZHBA	4M1SC10	400-1-10 ST	1/4	7/8-14	1.60	.70	1.31	.50	1	3-910
5-5 ZHBA	5M1SC5	500-1-5 ST	5/16	1/2-20	1.37	.73	1.08	.36	5/8	3-905
6-4 ZHBA	6M1SC4	600-1-4 ST	3/8	7/16-20	1.40	.76	1.11	.36	5/8	3-904
6-6 ZHBA	6M1SC6	600-1-6 ST	3/8	9/16-18	1.46	.76	1.17	.39	11/16	3-906
6-8 ZHBA	6M1SC8	600-1-8 ST	3/8	3/4-16	1.54	.76	1.25	.44	7/8	3-908
6-10 ZHBA	6M1SC10	600-1-10 ST	3/8	7/8-14	1.67	.76	1.38	.50	1.00	3-910
8-6 ZHBA	8M1SC6	810-1-6 ST	1/2	9/16-18	1.54	.87	1.14	.39	7/8	3-906
8-8 ZHBA	8M1SC8	810-1-8 ST	1/2	3/4-16	1.65	.87	1.25	.44	7/8	3-908
8-12 ZHBA	8M1SC12	810-1-12 ST	1/2	1-1/16-12	1.93	.87	1.53	.59	1-1/4	3-912
10-10 ZHBA	10M1SC10	1010-1-10 ST	5/8	7/8-14	1.78	.87	1.38	.50	1	3-910
12-10 ZHBA	12M1SC10	1210-1-10 ST	3/4	7/8-14	1.68	.87	1.28	.50	1-1/8	3-910
12-12 ZHBA	12M1SC12	1210-1-12 ST	3/4	1-1/16-12	1.93	.87	1.53	.59	1-1/4	3-912
12-14 ZHBA	14M1SC14	1410-1-14 ST	7/8	1-3/16-12	1.93	.87	1.53	.59	1-3/8	3-914
16-12 ZHBA	16M1SC12	1610-1-12 ST	1	1-1/16-12	2.12	1.05	1.63	.59	1-3/8	3-912
16-16 ZHBA	16M1SC16	1610-1-16 ST	1	1-5/16-12	2.15	1.04	1.66	.59	1-1/2	3-916
20-20 ZHBA	20M1SC20	2010-1-20 ST	1-1/4	1-5/8-12	2.59	1.52	1.82	.59	1-7/8	3-920
24-24 ZHBA	24M1SC24	2410-1-24 ST	1-1/2	1-7/8-12	3.05	1.77	1.99	.59	2-1/8	3-924
32-32 ZHBA	32M1SC32	3210-1-32 ST	2	2-1/2-12	4.00	2.47	2.53	.59	2-3/4	3-932

NOTE: A and C dimensions are typical finger-tight.

For use with SAE J.1926/1 port can also be used with MS-16142 port.

Sizes 20, 24, 32 require additional lubrication prior to assembly.

Parts are supplied with nitrile o-rings as standard. For Fluorocarbon o-rings, add the suffix "-VO". Other o-rings available upon request.

Dimensions for reference only, subject to change.

## Color Coding

For easy reference, table heads are color indicated as follows:

**fractional**



**metric**



## C5BZ, M5SEL Male SAE Straight Thread Elbow For fractional tube

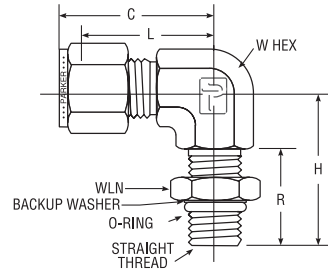
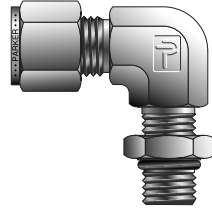

CPI™ PART NO.	A-LOK® PART NO.	INTER- CHANGES WITH	INCHES							O-RING ARP UNIFORM DASH NO.
			TUBE O.D.	STRAIGHT THREAD SIZE	C	H	L	R	W HEX	
4-4 C5BZ	4M5SEL4	400-2-4ST	1/4	7/16-20	1.12	1.18	.83	.83	9/16	3-904
6-6 C5BZ	6M5SEL6	600-2-6ST	3/8	9/16-18	1.26	1.27	.97	.84	9/16	3-906
8-8 C5BZ	8M5SEL8	810-2-8ST	1/2	3/4-16	1.48	1.48	1.08	.97	3/4	3-908
12-12 C5BZ	12M5SEL12	1210-2-12ST	3/4	1-1/16-12	1.63	1.92	1.23	1.28	1-1/16	3-912
16-16 C5BZ	16M5SEL16	1610-2-16ST	1	1-5/16-12	1.91	2.11	1.42	1.28	1-5/16	3-916
24-24 C5BZ	24M5SEL24	2410-2-24ST	1-1/2	1-7/8-12	3.47	2.33	2.00	1.16	1-7/8	3-924

NOTE: C dimension is typical finger-tight.

Dimensions for reference only, subject to change.

Size 24 requires additional lubrication prior to assembly.

Parts are supplied with nitrile o-rings as standard. For Fluorocarbon o-rings, add the suffix "-VO". Other o-rings available upon request.

## CBZ, MSEL (R) BSPB Male Elbow (Positionable) For fractional tube

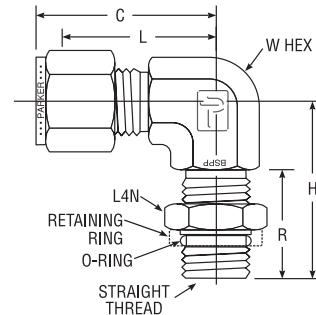
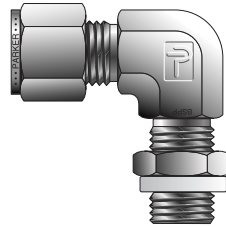

CPI™ PART NO.	A-LOK® PART NO.	INTER- CHANGES WITH	INCHES						
			TUBE O.D.	BSPB THREAD	C	H	L	R	W HEX
4-2R CBZ	4MSEL2R	400-2-2PR	1/4	1/8-28	1.06	1.04	.77	.81	9/16
4-4R CBZ	4MSEL4R	400-2-4PR	1/4	1/4-19	1.14	1.27	.85	.83	9/16
6-4R CBZ	6MSEL4R	600-2-4PR	3/8	1/4-19	1.20	1.27	.85	.83	9/16
6-6R CBZ	6MSEL6R	600-2-6PR	3/8	3/8-19	1.31	1.46	1.02	.83	3/4
8-8R CBZ	8MSEL4R	810-2-4PR	1/2	1/4-19	1.50	1.38	1.10	.83	7/8
8-6R CBZ	8MSEL6R	810-2-6PR	1/2	3/8-19	1.50	1.46	1.10	.85	7/8
8-8R CBZ	8MSEL8R	810-2-8PR	1/2	1/2-14	1.50	1.71	1.10	1.09	7/8
10-10R CBZ	10MSEL8R	1010-2-8PR	5/8	1/2-14	1.50	1.81	1.10	1.09	1-1/16
12-8R CBZ	12MSEL8R	1210-2-8PR	3/4	1/2-14	1.57	1.81	1.17	1.09	1-1/16
12-12R CBZ	12MSEL12R	1210-2-12PR	3/4	3/4-14	1.57	1.92	1.17	1.20	1-1/16
16-12R CBZ	16MSEL12R	1610-2-12PR	1	3/4-14	1.93	2.11	1.45	1.20	1-5/16
16-16R CBZ	16MSEL16R	1610-2-16PR	1	1-11	1.93	2.11	1.45	1.20	1-5/16

NOTE: C dimension is typical finger-tight.

Dimensions for reference only, subject to change.

Connects fractional tube to female ISO parallel thread.

Parts are supplied with nitrile o-rings as standard. For Fluorocarbon o-rings, add the suffix "-VO". Other o-rings available upon request.

## Color Coding

For easy reference, table heads are color indicated as follows:

fractional

metric



## R5BZ, M5RT Male Run Tee SAE Straight Thread For fractional tube

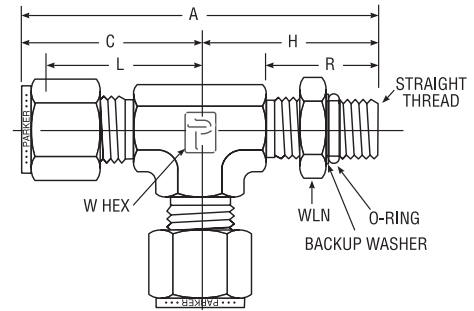
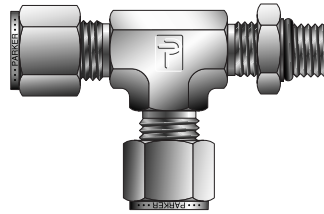

CPI™ PART NO.	A-LOK® PART NO.	INTER- CHANGES WITH	INCHES								O-RING ARP UNIFORM DASH NO.
			TUBE O.D.	STRAIGHT THREAD SIZE	A	C	H	L	R	W HEX	
4-4-4 R5BZ	4M5RT4	400-3TST	1/4	7/16-20	2.24	1.12	1.18	.83	.83	7/16	3-904
6-6-6 R5BZ	6M5RT6	600-3TST	3/8	9/16-18	2.53	1.26	1.27	.97	.84	9/16	3-906
8-8-8 R5BZ	8M5RT8	810-3TST	1/2	3/4-16	2.97	1.48	1.48	1.08	.97	3/4	3-908
12-12-12 R5BZ	12M5RT12	1210-3TST	3/4	1-1/16-12	3.55	1.63	1.92	1.23	1.28	1-1/16	3-912
16-16-16 R5BZ	16M5RT16	1610-3TST	1	1-5/16-12	3.74	1.87	2.11	1.38	1.28	1-5/16	3-916

NOTE: A and C dimensions are typical finger-tight.

Dimensions for reference only, subject to change.

Parts are supplied with nitrile o-rings as standard. For Fluorocarbon o-rings, add the suffix "-VO". Other o-rings available upon request.

## RBZ, MRT (R) BSPP Male Run Tee (Positionable) For fractional tube

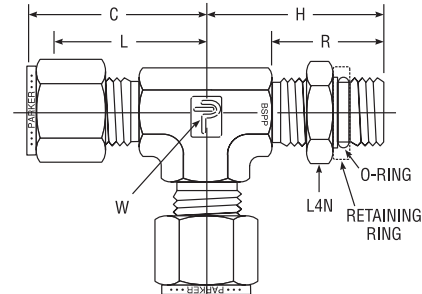
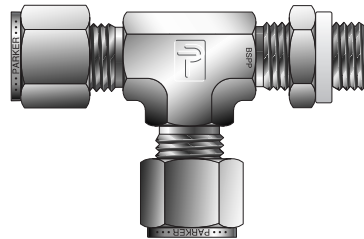

CPI™ PART NO.	A-LOK® PART NO.	INTER- CHANGES WITH	INCHES						
			TUBE O.D.	BSPP THREAD	C	H	L	R	W HEX
4-2R-4 RBZ	4MRT2R	400-3TRT	1/4	1/8-28	1.06	1.04	.77	.81	9/16
4-4R-4 RBZ	4MRT4R	400-3-4TRT	1/4	1/4-19	1.14	1.27	.85	.83	9/16
6-6R-6 RBZ	6MRT6R	600-3TRT	3/8	1/4-19	1.20	1.27	.91	.83	9/16
8-6R-8 RBZ	8MRT8R	810-3TRT	1/2	3/8-19	1.50	1.46	1.10	.85	7/8
8-8R-8 RBZ	8MRT8R	810-3-8TRT	1/2	1/2-14	1.50	1.71	1.10	1.09	7/8
10-8R-10 RBZ	10MRT8R	1010-3TRT	5/8	1/2-14	1.50	1.81	1.10	1.09	1-1/16
12-8R-12 RBZ	12MRT8R	1210-3-8TRT	3/4	1/2-14	1.57	1.81	1.17	1.09	1-1/16
12-12R-12 RBZ	12MRT12R	1210-3TRT	3/4	3/4-14	1.57	1.92	1.17	1.20	1-1/16
16-16R-16 RBZ	16MRT16R	1610-3TRT	1	1-11	1.93	2.11	1.45	1.20	1-5/16

NOTE: C dimension is typical finger-tight.

Dimensions for reference only, subject to change.

Parts are supplied with nitrile o-rings as standard. For Fluorocarbon o-rings, add the suffix "-VO". Other o-rings available upon request.

## S5BZ, M5BT Male Branch Tee SAE Straight Thread For fractional tube

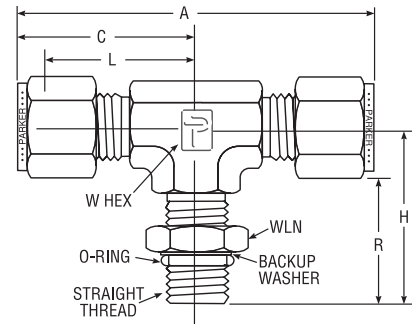
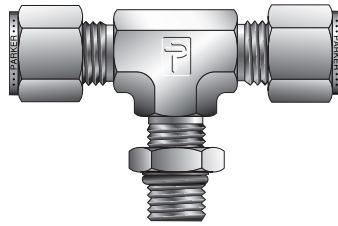

CPI™ PART NO.	A-LOK® PART NO.	INTER- CHANGES WITH	INCHES								O-RING ARP UNIFORM DASH NO.
			TUBE O.D.	STRAIGHT THREAD SIZE	A	C	H	L	R	W HEX	
4-4-4 S5BZ	4M5BT4	400-3TTS	1/4	7/16-20	2.24	1.19	1.19	.81	.81	7/16	3-904
6-6-6 S5BZ	6M5BT6	600-3TTS	3/8	9/16-18	2.52	1.26	1.27	.97	.84	9/16	3-906
8-8-8 S5BZ	8M5BT8	810-3TTS	1/2	3/4-16	2.96	1.48	1.48	1.08	.97	3/4	3-908
12-12-12 S5BZ	12M5BT12	1210-3TTS	3/4	1-1/16-12	3.26	1.63	1.92	1.23	1.28	1-1/16	3-912
16-16-16 S5BZ	16M5BT16	1610-3TTS	1	1-5/16-12	3.74	1.87	2.11	1.38	1.28	1-5/16	3-916

NOTE: A and C dimensions are typical finger-tight.

Dimensions for reference only, subject to change.

Parts are supplied with nitrile o-rings as standard. For Fluorocarbon o-rings, add the suffix "-VO". Other o-rings available upon request.

## SBZ, MBT (R) BSP Male Branch Tee (Positionable) For fractional tube

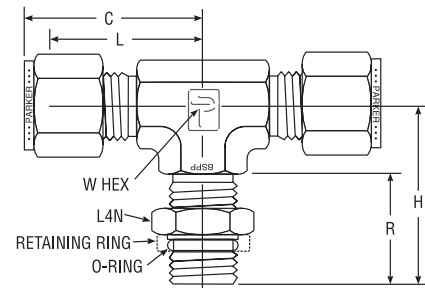
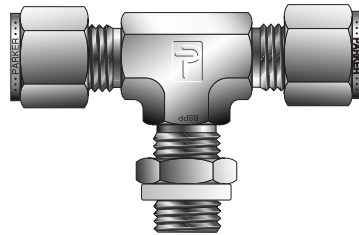

CPI™ PART NO.	A-LOK® PART NO.	INTER- CHANGES WITH	INCHES						
			TUBE O.D.	BSP THREAD	C	H	L	R	W HEX
4-4-2R SBZ	4MBT2R	400-3TTR	1/4	1/8-28	1.06	1.25	.77	.81	9/16
4-4-4R SBZ	4MBT4R	400-3-4TTR	1/4	1/4-19	1.14	1.27	.85	.83	9/16
6-6-4R SBZ	6MBT4R	600-3TTR	3/8	1/4-19	1.20	1.27	.91	.83	9/16
8-8-6R SBZ	8MBT6R	810-3TTR	1/2	3/8-19	1.50	1.36	1.10	.85	7/8
8-8-8R SBZ	8MBT8R	810-3-8TTR	1/2	1/2-14	1.50	1.71	1.10	1.09	7/8
10-10-8R SBZ	10MBT8R	1010-3TTR	5/8	1/2-14	1.50	1.81	1.10	1.09	1-1/16
12-12-8R SBZ	12MBT8R	1210-3-8TTR	3/4	1/2-14	1.57	1.81	1.17	1.09	1-1/16
12-12-12R SBZ	12MBT12R	1210-3-TTR	3/4	3/4-14	1.57	1.92	1.17	1.20	1-1/16
16-16-16R SBZ	16MBT16R	1610-3TTR	1	1-11	1.94	2.11	1.45	1.20	1-5/16

NOTE: C dimension is typical finger-tight.

Dimensions for reference only, subject to change.

Connects fractional tube to female ISO parallel thread.

Parts are supplied with nitrile o-rings as standard. For Fluorocarbon o-rings, add the suffix "-VO". Other o-rings available upon request.

## Color Coding

For easy reference, table heads are color indicated as follows:

### fractional



### metric



## ZH3BA, ZH3LA Long Male Connector SAE/MS Straight Thread For fractional tube

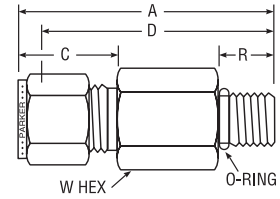
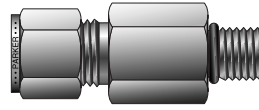

CPI™ PART NO.	A-LOK® PART NO.	INTER- CHANGES WITH	T TUBE O.D.	S-SAE/MS THREAD SIZE	INCHES						ST O-RING UNIFORM SIZE NO.
					A	R	C	D	E MIN. OPENING	W HEX	
4-4 ZH3BA	4-4 ZH3LA	400-1L-4ST	1/4	7/16-20	2.26	.36	.70	1.97	.19	9/16	-904
6-6 ZH3BA	6-6 ZH3LA	600-1L-6ST	3/8	9/16-18	2.48	.39	.76	2.19	.28	11/16	-906
8-8 ZH3BA	8-8 ZH3LA	810-1L-8ST	1/2	3/4-16	3.01	.44	.86	2.58	.41	7/8	-908
12-12 ZH3BA	12-12 ZH3LA	1210-1L-12ST	3/4	1-1/16-12	3.88	.59	.86	3.48	.62	1-1/4	-912
16-16 ZH3BA	16-16 ZH3LA	1610-1L-16ST	1	1-5/16-12	4.34	.59	1.04	3.86	.88	1-1/2	-916

NOTE: A and C dimensions are typical finger-tight.

Dimensions for reference only, subject to change.

Parts are supplied with nitrile o-rings as standard. For Fluorocarbon o-rings, add the suffix "-VO". Other o-rings available upon request.

## V5BZ, M5VEL 45° Positionable Male Elbow SAE/MS Straight Thread For fractional tube

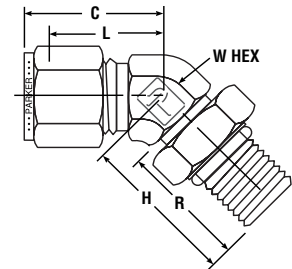
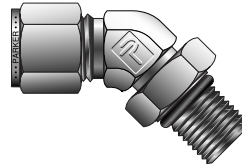

CPI™ PART NO.	A-LOK® PART NO.	INTER- CHANGES WITH	STRAIGHT TUBE O.D.	THREAD SIZE	INCHES					O-RING UNIFORM SIZE NUMBER
					C	H	L	R	W HEX	
4-4 V5BZ	4M5VEL4	400-5-4ST	1/4	7/16-20	.93	1.02	.65	.75	7/16	3-904
6-6 V5BZ	6M5VEL6	600-5-6ST	3/8	9/16-18	1.01	1.27	.72	.77	9/16	3-906
8-8 V5BZ	8M5VEL8	810-5-8ST	1/2	3/4-16	1.15	1.48	.75	.88	3/4	3-908
12-12 V5BZ	12M5VEL12	1210-5-12ST	3/4	1-1/16-12	1.63	1.92	1.23	1.16	1-1/16	3-912
16-16 V5BZ	16M5VEL16	1610-5-16ST	1	1-5/16-12	1.87	2.11	1.39	1.16	1-5/16	3-916

NOTE: C dimension is typical finger-tight.

Dimensions for reference only, subject to change.

• Adapts to SAE J1926 straight thread boss and MS16142 boss.

Parts are supplied with nitrile o-rings as standard. For Fluorocarbon o-rings, add the suffix "-VO". Other o-rings available upon request.

## ZHBA5, M2SC Male Connector to O-Ring Straight Thread For fractional tube

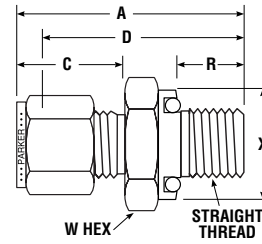
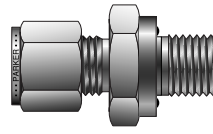

CPI™ PART NO.	A-LOK® PART NO.	INTER- CHANGES WITH	INCHES								O-RING ARP UNIFORM DASH NO.
			TUBE O.D.	STRAIGHT THREAD SIZE	A	C	D	R	X DIA.	W HEX	
1-2 ZHBA5	1M2SC2	100-1-OR	1/16	5/16-24	1.06	.43	.91	.34	.55	9/16	2-011
2-2 ZHBA5	2M2SC2	200-1-OR	1/8	5/16-24	1.29	.60	1.03	.34	.55	9/16	2-011
3-3 ZHBA5	3M2SC3	300-1-OR	3/16	3/8-24	1.35	.64	1.09	.38	.62	5/8	2-012
4-4 ZHBA5	4M2SC4	400-1-OR	1/4	7/16-20	1.51	.70	1.22	.41	.74	3/4	2-111
5-5 ZHBA5	5M2SC5	500-1-OR	5/16	1/2-20	1.61	.73	1.31	.44	.86	7/8	2-112
6-6 ZHBA5	6M2SC6	600-1-OR	3/8	9/16-18	1.67	.76	1.38	.44	.93	15/16	2-113
8-8 ZHBA5	8M2SC8	810-1-OR	1/2	3/4-16	1.81	.87	1.41	.47	1.12	1-1/8	2-116
10-10 ZHBA5	10M2SC10	1010-1-OR	5/8	7/8-14	1.90	.87	1.50	.47	1.30	1-3/8	2-212
12-12 ZHBA5	12M2SC12	1210-1-OR	3/4	1-1/16-12	2.06	.87	1.66	.56	1.49	1-1/2	2-215
14-12 ZHBA5	14M2SC12	1410-1-OR	7/8	1-1/16-12	2.06	.87	1.66	.56	1.49	1-1/2	2-215
16-16 ZHBA5	16M2SC16	1610-1-OR	1	1-5/16-12	2.30	1.05	1.81	.56	1.74	1-3/4	2-219

**NOTE:** A and C dimensions are typical finger-tight.

Dimensions for reference only, subject to change.

Parts are supplied with nitrile o-rings as standard. For Fluorocarbon o-rings, add the suffix "-VO". Other o-rings available upon request.

## ZHBF5, M3SC Male Connector to O-Ring Pipe Thread For fractional tube

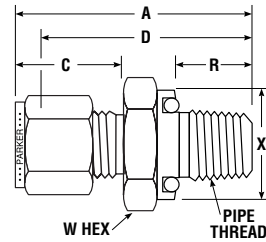
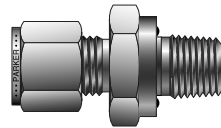

CPI™ PART NO.	A-LOK® PART NO.	INTER- CHANGES WITH	INCHES								O-RING ARP UNIFORM DASH NO.
			TUBE O.D.	NPT PIPE THREAD	A	C	D	R	X DIA.	W HEX	
1-2 ZHBF5	1M3SC2	100-1-2-OR	1/16	1/8	1.12	.43	.97	.28	.74	3/4	2-011
2-2 ZHBF5	2M3SC2	200-1-2-OR	1/8	1/8	1.29	.60	1.03	.28	.74	3/4	2-011
2-4 ZHBF5	2M3SC4	200-1-4-OR	1/8	1/4	1.43	.60	1.17	.38	.93	15/16	2-113
3-2 ZHBF5	3M3SC2	300-1-2-OR	3/16	1/8	1.32	.64	1.06	.28	.74	3/4	2-011
3-4 ZHBF5	3M3SC4	300-1-4-OR	3/16	1/4	1.46	.64	1.20	.38	.93	15/16	2-113
4-2 ZHBF5	4M3SC2	400-1-2-OR	1/4	1/8	1.38	.70	1.09	.28	.74	3/4	2-011
4-4 ZHBF5	4M3SC4	400-1-4-OR	1/4	1/4	1.51	.70	1.22	.38	.93	15/16	2-113
4-6 ZHBF5	4M3SC6	400-1-6-OR	1/4	3/8	1.57	.70	1.28	.41	1.12	1-1/8	2-116
5-2 ZHBF5	5M3SC2	500-1-2-OR	5/16	1/8	1.43	.73	1.13	.28	.74	3/4	2-011
5-4 ZHBF5	5M3SC4	500-1-4-OR	5/16	1/4	1.46	.73	1.25	.38	.93	15/16	2-113
6-2 ZHBF5	6M3SC2	600-1-2-OR	3/8	1/8	1.45	.76	1.16	.28	.74	3/4	2-011
6-4 ZHBF5	6M3SC4	600-1-4-OR	3/8	1/4	1.57	.76	1.28	.38	.93	15/16	2-113
6-6 ZHBF5	6M3SC6	600-1-6-OR	3/8	3/8	1.63	.76	1.34	.41	1.12	1-1/8	2-116
6-8 ZHBF5	6M3SC8	600-1-8-OR	3/8	1/2	1.85	.76	1.56	.53	1.30	1-3/8	2-212
8-4 ZHBF5	8M3SC4	810-1-4-OR	1/2	1/4	1.68	.87	1.28	.38	.93	15/16	2-113
8-6 ZHBF5	8M3SC6	810-1-6-OR	1/2	3/8	1.76	.87	1.36	.41	1.12	1-1/8	2-116
8-8 ZHBF5	8M3SC8	810-1-8-OR	1/2	1/2	1.98	.87	1.58	.53	1.30	1-3/8	2-212
10-8 ZHBF5	10M3SC8	1010-1-8-OR	5/8	1/2	1.96	.87	1.56	.53	1.30	1-3/8	2-212
10-12 ZHBF5	10M3SC12	1010-1-8-OR	5/8	3/4	2.06	.87	1.66	.56	1.49	1-1/2	2-215
12-8 ZHBF5	12M3SC8	1210-1-8-OR	3/4	1/2	1.98	.87	1.58	.53	1.30	1-3/8	2-212
12-12 ZHBF5	12M3SC12	1210-1-12-OR	3/4	3/4	2.06	.87	1.66	.56	1.49	1-1/2	2-215
16-12 ZHBF5	16M3SC12	1610-1-12-OR	1	3/4	2.24	1.05	1.75	.56	1.49	1-1/2	2-215
16-16 ZHBF5	16M3SC16	1610-1-16-OR	1	1	2.40	1.05	1.91	.66	1.74	1-3/4	2-219

**NOTE:** A and C dimensions are typical finger-tight.

Dimensions for reference only, subject to change.

Parts are supplied with nitrile o-rings as standard. For Fluorocarbon o-rings, add the suffix "-VO". Other o-rings available upon request.

## T2HOA5, M2TU Tube End to O-Ring Straight Thread For fractional tube

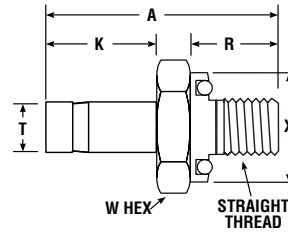
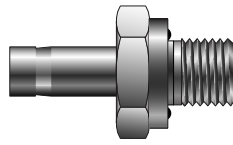

CPI™ PART NO.	A-LOK® PART NO.	INTER- CHANGES WITH	T TUBE O.D.	STRAIGHT THREAD SIZE	INCHES					O-RING ARP UNIFORM DASH NO.
					A	K	R	X DIA.	W HEX	
2-2 T2HOA5	2M2TU2	2-TA-OR-ST	1/8	5/16-24	1.22	.53	.34	.55	9/16	2-011
3-3 T2HOA5	3M2TU3	3-TA-OR-ST	3/16	3/8-24	1.38	.56	.38	.62	5/8	2-012
4-4 T2HOA5	4M2TU4	4-TA-OR-ST	1/4	7/16-20	1.55	.63	.41	.74	3/4	2-111
5-5 T2HOA5	5M2TU5	5-TA-OR-ST	5/16	1/2-20	1.64	.66	.44	.86	7/8	2-112
6-6 T2HOA5	6M2TU6	6-TA-OR-ST	3/8	9/16-18	1.70	.69	.47	.93	15/16	2-113
8-8 T2HOA5	8M2TU8	8-TA-OR-ST	1/2	3/4-16	1.95	.91	.47	1.12	1-1/8	2-116
10-10 T2HOA5	10M2TU10	10-TA-OR-ST	5/8	7/8-14	2.12	.97	.47	1.30	1-3/8	2-212
12-12 T2HOA5	12M2TU12	12-TA-OR-ST	3/4	1-1/16-12	2.16	.97	.56	1.49	1-1/2	2-215
16-16 T2HOA5	16M2TU16	16-TA-OR-ST	1	1-5/16-12	2.47	1.22	.56	1.74	1-3/4	2-219

**NOTE:** Add -Z6 for assembly of nuts and ferrules on the tube stub end. Dimensions for reference only, subject to change. Parts are supplied with nitrile o-rings as standard. For Fluorocarbon o-rings, add the suffix "-VO". Other o-rings available upon request.

## T2HOF5, M3TU Tube End to O-Ring Pipe Thread For fractional tube

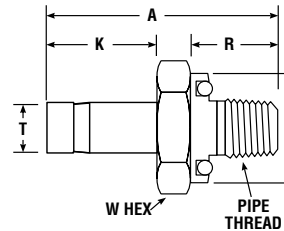
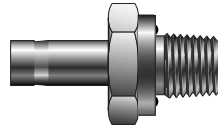

CPI™ PART NO.	A-LOK® PART NO.	INTER- CHANGES WITH	T TUBE O.D.	NPT PIPE THREAD	INCHES					O-RING ARP UNIFORM DASH NO.
					A	K	R	X DIA.	W HEX	
1-2 T2HOF5	1M3TU2	1-TA-1-2OR	1/16	1/8	1.03	.34	.28	.74	3/4	2-111
4-2 T2HOF5	4M3TU2	4-TA-1-2OR	1/4	1/8	1.31	.63	.28	.74	3/4	2-111
4-4 T2HOF5	4M3TU4	4-TA-1-4OR	1/4	1/4	1.44	.63	.38	.93	15/16	2-113
4-6 T2HOF5	4M3TU6	4-TA-1-6OR	1/4	3/8	1.50	.63	.41	1.12	1-1/8	2-116
5-2 T2HOF5	5M3TU2	5-TA-1-2OR	5/16	1/8	1.34	.66	.28	.74	3/4	2-111
5-4 T2HOF5	5M3TU4	5-TA-1-4OR	5/16	1/4	1.47	.66	.38	.93	15/16	2-113
6-2 T2HOF5	6M3TU2	6-TA-1-2OR	3/8	1/8	1.38	.69	.28	.74	3/4	2-111
6-4 T2HOF5	6M3TU4	6-TA-1-4OR	3/8	1/4	1.50	.69	.38	.93	15/16	2-113
6-6 T2HOF5	6M3TU6	6-TA-1-6OR	3/8	3/8	1.59	.69	.41	1.12	1-1/8	2-116
8-6 T2HOF5	8M3TU6	8-TA-1-6OR	1/2	3/8	1.78	.91	.41	1.12	1-1/8	2-116
10-8 T2HOF5	10M3TU8	10-TA-1-8OR	5/8	1/2	2.14	.97	.53	1.30	1-3/8	2-212
12-12 T2HOF5	12M3TU12	12-TA-1-12OR	3/4	3/4	2.16	.97	.56	1.49	1-1/2	2-215
16-16 T2HOF5	16M3TU16	16-TA-1-16OR	1	1	2.56	1.22	.66	1.65	1-3/4	2-219

**NOTE:** Add -Z6 for assembly of nuts and ferrules on the tube stub end. Dimensions for reference only, subject to change. Parts are supplied with nitrile o-rings as standard. For Fluorocarbon o-rings, add the suffix "-VO". Other o-rings available upon request.

## Color Coding

For easy reference, table heads are color indicated as follows:

fractional



metric



## FHOA, FHOA Pipe Thread to SAE Straight Thread Adapter For fractional tube

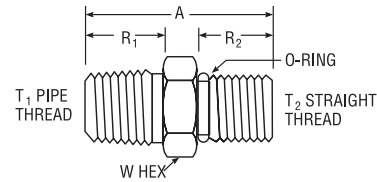
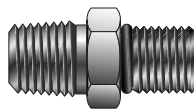

CPI™ PART NO.	A-LOK® PART NO.	INTER- CHANGES WITH	INCHES						O-RING AS UNIFORM DASH NO.
			T <sub>2</sub> STRAIGHT THREAD	NPT T <sub>1</sub> PIPE THREAD	A	R <sub>1</sub>	R <sub>2</sub>	W HEX	
4-4 FHOA	4-4 FHOA	4SAE-1-4	1/4-18	7/16-20	1.20	.56	.36	9/16	3-904
6-6 FHOA	6-6 FHOA	6-SAE-1-6	3/8-18	9/16-18	1.26	.56	.39	11/16	3-906
8-8 FHOA	8-8 FHOA	8-SAE-1-8	1/2-14	3/4-16	1.53	.75	.44	7/8	3-908
12-12 FHOA	12-12 FHOA	12-SAE-1-12	3/4-14	1-1/16-12	1.75	.75	.59	1-1/4	3-912
16-16 FHOA	16-16 FHOA	16-SAE-1-16	1-11-1/2	1-5/16-12	2.00	.94	.59	1-1/2	3-916

**NOTE:** A and C dimensions are typical finger-tight.

Dimensions for reference only, subject to change.

For use with SAE J.1926/1 port can also be used with MS-16142 port.

Parts are supplied with nitrile o-rings as standard. For Fluorocarbon o-rings, add the suffix "-VO".

Other o-rings available upon request.

## AH2BZ, AH2LZ Bulkhead to Conversion Adapter For fractional tube

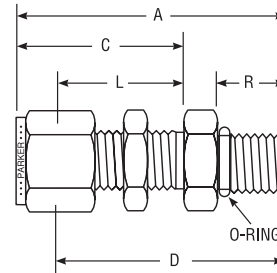
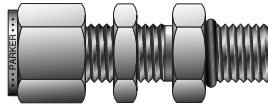

CPI™ PART NO.	A-LOK® PART NO.	INTER- CHANGES WITH	INCHES									
			TUBE O.D.	STRAIGHT THREAD SIZE	A	C	D	R	L	W HEX	BULKHEAD HOLD DRILL SIZE	MAX. BULKHEAD THICKNESS
4-6 AH2BZ	4-6 AH2LZ	400-61-6ST	1/4	9/16-18	1.74	1.17	1.45	.39	.88	3/4	37/64	9/16
6-6 AH2BZ	6-6 AH2LZ	600-61-6ST	3/8	9/16-18	1.81	1.24	1.52	.39	.94	3/4	37/64	9/16

**NOTE:** A and C dimensions are typical finger-tight.

Dimensions for reference only, subject to change.

For use with SAE J.1926/1 port can also be used with MS-16142 port.

Parts are supplied with nitrile o-rings as standard. For Fluorocarbon o-rings, add the suffix "-VO".

Other o-rings available upon request.

## Color Coding

For easy reference, table heads are color indicated as follows:

### fractional



### metric





## General

The weld used in joining a tube to a socket weld tube fitting is like any other type of “tee” weld. The root (i.e., the point of intersection of the outside of the tube and annular end area of the fitting) must be included in the weld zone.

Careful welding procedures are normally followed to assure that this root area is included in the weld. If penetration is not achieved, the joint will have two built-in stress risers which may greatly reduce the strength of the weld. Upon application of an extreme load, these stress risers could result in cracks which could propagate out through the weld or tube depending upon the direction of the greatest load.

Often to achieve full root penetration in TIG welding of stainless steels, a fusion pass will be made first, followed by a final pass utilizing a filler rod to achieve the desired fillet size.

## Assembly

The codes applicable to the welding of socket weld fittings require that the tube be inserted into the socket until bottomed against the stop. The tube is then to be backed out approximately 1/16 of an inch and then welded.

If the tube is not backed out, but welded when against a flat bottom stop, the contraction of the weld fillet and fitting socket can combine to produce a static stress on the weld. During thermal transients, the fitting and the portion of the tube within the fitting may experience a differential rate of heating or cooling, again adding to the stress level in the weld.

## Tacking

If the weld joint is to be “tacked” before welding, it is recommended that the “Tack” weld build-up be held to a minimum.

Excessive build-up on the “tack” may cause an interrupted final bead and a stress riser or lack of complete fusion.

## Backing Gas

Backing gas is an inert gas used to flood the interior of the fittings and tube system during welding. It serves the same purpose internally as the shielding gas used in TIG or MIG welding. By reducing the interior oxygen level to as low as practicable, it also serves to control the combustion of contaminants that could affect weld quality.

When a backing gas is not used and nearly 100% weld penetration is achieved, blisters will tend to form on the internal tube wall. This will result in scale which may later break loose. Therefore, in 0.050 wall or thinner tube or where the wall thickness is such that the selected weld process may burn through, the use of a backing gas is mandatory.

In most cases the backing gas will be argon or helium connected to the system through a control regulator. Flow rates, while small, should be high enough to purge the system. Welds should be made in downstream sequence from the gas connection.

Note that the entire system should be purged to insure that there are no openings that will allow air to be drawn into the system.

The use of backing gas, while often not mandatory, will give a better weld joint. This is because the effects of contaminate combustion by-products are eliminated and because the welds are made and cooled under a shielded atmosphere, thus eliminating internal scaling or blistering.

## Welding Methods 300 Series Stainless Steels

May be welded by the TIG, MIG, or stick arc-weld process.

TIG welding is recommended as being best for welding Weld-lok systems because it allows better operator control of heat penetration and filler material deposition.

Stick arc welding is not recommended in many cases because of the likelihood of excessive burn-through and improper root penetration. In all cases where stick welding is used, it is recommended that backing gas be used.

MIG welding gives the same characteristics as stick electrode welding with faster deposition of the filler material. As this process runs “hotter” than the stick process, the use of a backing gas is mandatory. It should be noted that in welding the relatively small fitting sizes found in the Weld-lok line, filler deposition rate economies are not a factor and therefore the MIG method is not commonly applied.

## C1018 Steel Fittings

May be welded by the TIG, MIG, stick and oxyacetylene methods. As scale formation remains a problem, the use of a backing gas is still recommended.

## Carbide Precipitation

When unstabilized stainless steels are heated to 800°–1500°F during welding, the chromium in the steel combines with the carbon to form chrome carbides which tend to form along the grain boundaries of the metal (carbide precipitation). This lowers the dissolved chromium content in these areas and thus lowers their corrosion resistance, making them vulnerable to intergranular corrosion. Carbide precipitation is reduced by holding the carbon content of the material to a very low value. This limits the amount of carbon available to combine with the chromium. The “L” series (extra low carbon) stainless steels are often used for this purpose, but their use reduces system design stress by approximately 15%. Parker Weld-lok fittings are made from a select 316 series with carbon content in the low range of 0.04 to 0.07 percent. This results in a welded fitting with good corrosion resistance and a high strength factor.

All Parker Weld-lok fittings in stainless steel are supplied in the solution treated condition, capable of passing ASTM-A-262 Tests for Detecting Susceptibility to Intergranular Corrosion.

## Arc Polarity

When welding Weld-lok fittings, best results will be obtained by the following arc polarities:

- TIG – Direct Current, straight polarity
- MIG – Direct Current, reverse polarity
- STICK – Polarity dependent on rod used

For further information on Parker's Welded Fittings refer to Parker's Welded Fittings Catalog 4280 or contact Parker's Instrumentation Products Division – Product Engineering at 256-881-2040.

## ZEBW, ZELW Socket Weld Elbow

**For fractional tube**

• for CPI™/A-LOK® to tubing socket weld connection

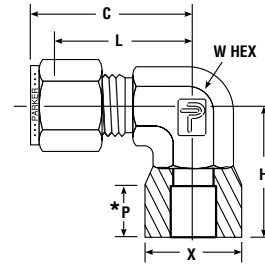
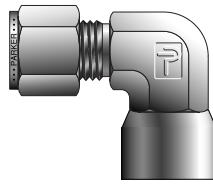

CPI™ PART NO.	A-LOK® PART NO.	INTER- CHANGES WITH	INCHES						
			TUBE O.D.	C	L	H	P*	X	W HEX
2-2 ZEBW	2-2 ZELW	200-9-2 W	1/8	.92	.66	.63	.16	.38	5/16
3-3 ZEBW	3-3 ZELW	300-9-3 W	3/16	.98	.72	.69	.20	.44	7/16
4-4 ZEBW	4-4 ZELW	400-9-4 W	1/4	1.06	.78	.84	.25	.50	9/16
6-6 ZEBW	6-6 ZELW	600-9-6 W	3/8	1.31	1.02	1.08	.34	.63	3/4
8-8 ZEBW	8-8 ZELW	810-9-8 W	1/2	1.42	1.02	1.14	.41	.76	3/4
10-10 ZEBW	10-10 ZELW	1010-9-10 W	5/8	1.57	1.17	1.35	.49	.94	1-1/16
12-12 ZEBW	12-12 ZELW	1210-9-12 W	3/4	1.57	1.17	1.39	.50	1.09	1-1/16
16-16 ZEBW	16-16 ZELW	1610-9-16 W	1	1.93	1.65	1.84	.56	1.38	1-5/8

NOTE: C dimension is typical finger-tight.

Dimensions for reference only, subject to change.

\*Socket Depth

## ZEBW2, ZELW2 Butt Weld Elbow

**For fractional tube**

• for CPI™/A-LOK® to pipe butt weld connection

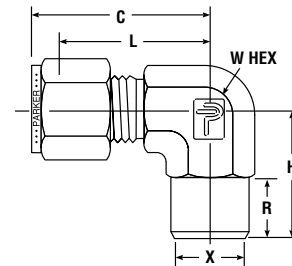
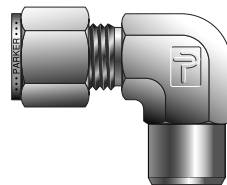

CPI™ PART NO.	A-LOK® PART NO.	INTER- CHANGES WITH	INCHES							
			TUBE O.D.	BUTT WELD PIPE SIZE	C	H	L	R	X BUTT WELD O.D.	W HEX
2-1/8 ZEBW2	2-1/8 ZELW2	200-2-2 W	1/8	1/8	.93	.70	.67	.38	.405	7/16
3-1/8 ZEBW2	3-1/8 ZELW2	300-2-2 W	3/16	1/8	1.01	.74	.74	.38	.405	7/16
4-1/8 ZEBW2	4-1/8 ZELW2	400-2-2 W	1/4	1/8	1.06	.74	.77	.38	.405	7/16
4-1/4 ZEBW2	4-1/4 ZELW2	400-2-4 W	1/4	1/4	1.10	.97	.78	.56	.540	9/16
6-1/4 ZEBW2	6-1/4 ZELW2	600-2-4 W	3/8	1/4	1.20	1.00	.91	.56	.540	5/8
8-3/8 ZEBW2	8-3/8 ZELW2	810-2-6 W	1/2	3/8	1.42	1.11	1.02	.56	.675	13/16
8-1/2 ZEBW2	8-1/2 ZELW2	810-2-8 W	1/2	1/2	1.42	1.30	1.02	.75	.840	7/8
10-1/2 ZEBW2	10-1/2 ZELW2	1010-2-8 W	5/8	1/2	1.50	1.39	1.10	.75	.840	15/16
12-3/4 ZEBW2	12-3/4 ZELW2	1210-2-12 W	3/4	3/4	1.57	1.45	1.17	.75	1.050	1-1/16
16-3/4 ZEBW2	16-3/4 ZELW2	1610-2-12 W	1	3/4	1.94	1.64	1.45	.75	1.050	1-3/8
16-1 ZEBW2	16-1 ZELW2	1610-2-16 W	1	1	1.94	1.84	1.45	.94	1.315	1-5/16

NOTE: C dimension is typical finger-tight.

Pipe butt weld end will conform to Schedule 80 unless otherwise noted.

Dimensions for reference only, subject to change.

## Color Coding

For easy reference, table heads are color indicated as follows:

**fractional**



**metric**



## ZHBW, ZHLW Socket Weld Connector

**For fractional tube**

- for CPI™/A-LOK® to tubing socket weld connection

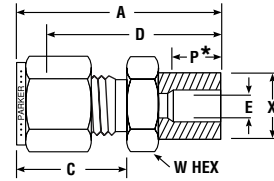
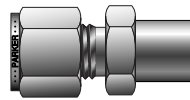

CPI™ PART NO.	A-LOK® PART NO.	INTER- CHANGES WITH	INCHES							
			TUBE O.D.	A	C	D	P*	X	E BORE	W HEX
2-2 ZHBW	2-2 ZHLW	200-6-2 W	1/8	1.16	.60	.90	.16	.38	.094	7/16
3-3 ZHBW	3-3 ZHLW	300-6-3 W	3/16	1.24	.64	.98	.20	.44	.141	1/2
4-4 ZHBW	4-4 ZHLW	400-6-4 W	1/4	1.36	.70	1.07	.25	.50	.188	9/16
6-6 ZHBW	6-6 ZHLW	600-6-6 W	3/8	1.53	.76	1.24	.34	.63	.313	11/16
8-8 ZHBW	8-8 ZHLW	810-6-8 W	1/2	1.77	.87	1.34	.41	.78	.438	13/16
10-10 ZHBW	10-10 ZHLW	1010-6-10 W	5/8	1.86	.87	1.46	.47	.94	.500	1
12-12 ZHBW	12-12 ZHLW	1210-6-12 W	3/4	1.92	.87	1.52	.50	1.09	.656	1-1/8
16-16 ZHBW	16-16 ZHLW	1610-6-16 W	1	2.31	1.05	1.82	.56	1.44	.906	1-5/8

**NOTE:** A and C dimensions are typical finger-tight.

Dimensions for reference only, subject to change.

\*Socket Depth

## ZHBW2, ZHLW2 Butt Weld Connector

**For fractional tube**

- for CPI™/A-LOK® to pipe butt weld connection

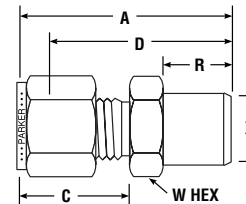
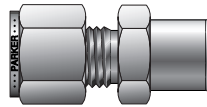

CPI™ PART NO.	A-LOK® PART NO.	INTER- CHANGES WITH	INCHES							
			TUBE O.D.	BUTTWELD PIPE SIZE	A	C	D	R	X BUTTWELD O.D.	W HEX
2-1/8 ZHBW2	2-1/8 ZHLW2	200-1-2 W	1/8	1/8	1.20	.60	.94	.38	.405	7/16
3-1/8 ZHBW2	3-1/8 ZHLW2	300-1-2 W	3/16	1/8	1.24	.61	.97	.38	.405	7/16
4-1/8 ZHBW2	4-1/8 ZHLW2	400-1-2 W	1/4	1/8	1.29	.66	1.00	.38	.405	1/2
4-1/4 ZHBW2	4-1/4 ZHLW2	400-1-4 W	1/4	1/4	1.46	.66	1.17	.56	.540	9/16
5-1/8 ZHBW2	5-1/8 ZHLW2	500-1-2 W	5/16	1/8	1.48	.73	1.22	.38	.405	1/2
5-1/4 ZHBW2	5-1/4 ZHLW2	500-1-4 W	5/16	1/4	1.49	.73	1.23	.56	.540	9/16
6-1/4 ZHBW2	6-1/4 ZHLW2	600-1-4 W	3/8	1/4	1.49	.70	1.20	.56	.540	9/16
6-3/8 ZHBW2	6-3/8 ZHLW2	600-1-6 W	3/8	3/8	1.60	.70	1.31	.56	.675	3/4
6-1/2 ZHBW2	6-1/2 ZHLW2	600-1-8 W	3/8	1/2	1.82	.70	1.53	.75	.840	7/8
6-3/4 ZHBW2	6-3/4 ZHLW2	600-1-12 W	3/8	3/4	1.88	.70	1.59	.75	1.050	1-1/8
8-3/8 ZHBW2	8-3/8 ZHLW2	810-1-6 W	1/2	3/8	1.71	.84	1.31	.56	.675	13/16
8-1/2 ZHBW2	8-1/2 ZHLW2	810-1-8 W	1/2	1/2	1.90	.84	1.50	.75	.840	7/8
8-3/4 ZHBW2	8-3/4 ZHLW2	810-1-12 W	1/2	3/4	1.96	.84	1.56	.75	1.050	1-1/16
10-1/2 ZHBW2	10-1/2 ZHLW2	1010-1-8 W	5/8	1/2	1.93	.87	1.53	.75	.840	15/16
12-3/4 ZHBW2	12-3/4 ZHLW2	1210-1-12 W	3/4	3/4	1.99	.87	1.59	.75	1.050	7/8
16-1 ZHBW2	16-1 ZHLW2	1610-1-16 W	1	1	2.46	.96	1.97	.94	1.310	1-1/16

**NOTE:** A and C dimensions are typical finger-tight.

Dimensions for reference only, subject to change.

Pipe Butt weld end will conform to Schedule 80 unless otherwise noted.

## ZHBW2, ZHLW2 Butt Weld Connector

For metric tube

- for CPI™/A-LOK® to pipe butt weld connection

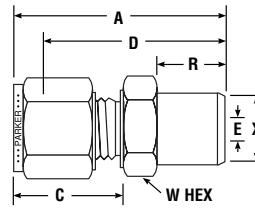
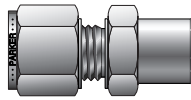

CPI™ PART NO.	A-LOK® PART NO.	INTER- CHANGES WITH	MILLIMETERS								
			TUBE O.D.	BUTT- WELD PIPE N.B.	A	C	D	R	X	E BORE	W HEX
ZHBW2 3-1/8	ZHLW2 3-1/8	3MO-1-2W	3	1/8	29,7	15,3	23,1	9,7	10,3	2,4*	12,0
ZHBW2 4-1/8	ZHLW2 4-1/8	4MO-1-2	4	1/8	30,7	16,1	24,1	9,7	10,3	2,4*	12,0
ZHBW2 6-1/8	ZHLW2 6-1/8	6MO-1-2	6	1/8	32,9	17,7	25,4	9,7	10,3	4,8	14,0
ZHBW2 6-1/4	ZHLW2 6-1/4	6MO-1-4W	6	1/4	37,7	17,7	30,2	14,2	13,7	4,8*	14,0
ZHBW2 8-1/8	ZHLW2 8-1/8	8MO-1-2	8	1/8	34,2	18,6	26,7	9,7	10,3	5,1	15,0
ZHBW2 8-1/4	ZHLW2 8-1/4	8MO-1-1/4	8	1/4	38,7	18,6	31,2	14,2	13,7	6,4	15,0
ZHBW2 8-1/2	ZHLW2 8-1/2	8MO-1-8	8	1/2	44,8	18,6	37,3	19,1	21,3	6,4*	22,0
ZHBW2 10-1/4	ZHLW2 10-1/4	—	10	1/4	40,9	19,5	33,3	14,2	13,7	7,1	18,0
ZHBW2 10-3/8	ZHLW2 10-3/8	10MO-1-6	10	3/8	40,1	19,5	32,5	14,2	17,2	7,9*	18,0
ZHBW2 10-1/2	ZHLW2 10-1/2	—	10	1/2	45,7	19,5	38,1	19,1	21,3	7,9*	22,0
ZHBW2 12-1/4	ZHLW2 12-1/4	—	12	1/4	43,4	22,0	33,3	14,2	13,7	7,1	22,0
ZHBW2 12-3/8	ZHLW2 12-3/8	—	12	3/8	43,4	22,0	33,3	14,2	17,2	9,5	22,0
ZHBW2 12-1/2	ZHLW2 12-1/2	12MO-1-8W	12	1/2	48,2	22,0	38,1	19,1	21,3	9,5*	22,0
ZHBW2 15-1/2	ZHLW2 15-1/2	—	16	1/2	48,2	22,0	38,9	19,1	21,3	9,5*	24,0
ZHBW2 16-1/2	ZHLW2 16-1/2	—	16	1/2	49,0	22,0	38,9	19,1	21,3	12,7*	24,0
ZHBW2 18-1/2	ZHLW2 18-1/2	—	18	1/2	50,5	22,0	40,4	19,1	21,3	13,5	27,0

NOTE: \*E dimension is minimum opening.

Fittings of this group may be back-drilled to larger I.D. at pipe end.

A and C dimensions are typical finger-tight.

Pipe Butt weld end will conform to Schedule 80 unless otherwise noted.

Dimensions for reference only, subject to change.

## Color Coding

For easy reference, table heads are color indicated as follows:

fractional



metric



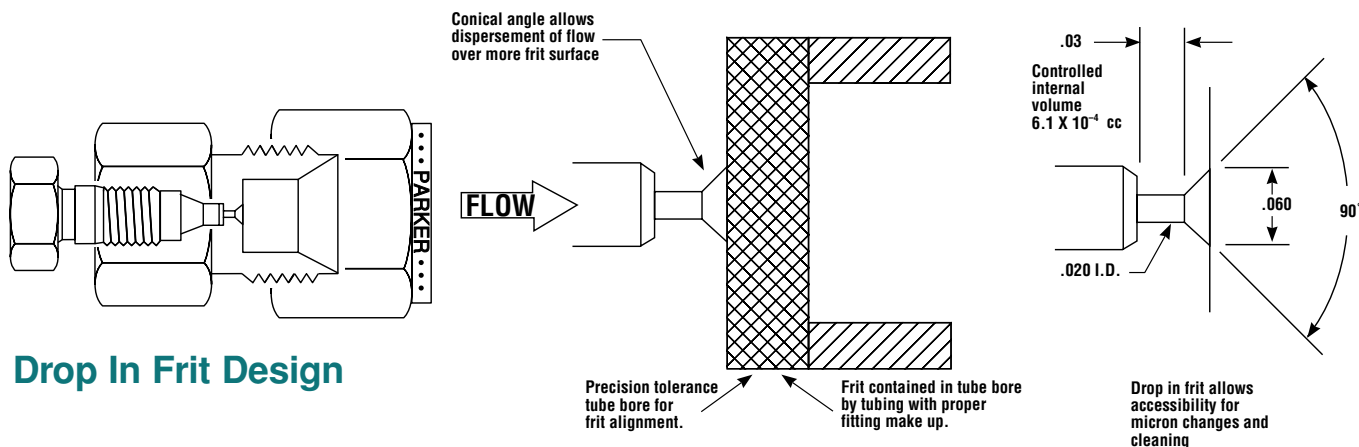

## Drop In Frit Design

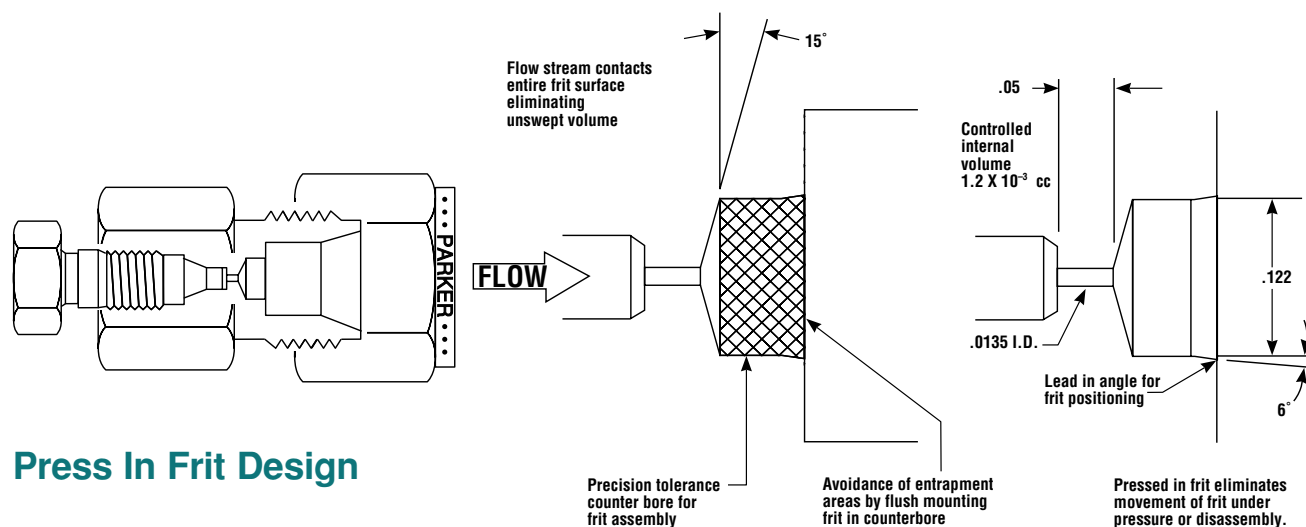

## Press In Frit Design

Parker Hannifin's Instrumentation Products Division offers a full line of analytical tube fittings. These fittings range from elbows, tees, and male connectors to low dead volume unions and column end fittings. Parker incorporates various features in the column end fittings to effectively address various industry concerns.

- Peak symmetry for critical analysis
- Internal volume reduction

As the observed media/substance migrates through the HPLC column, a "peak" or "band" is created that denotes the level of concentration. It is critical to maintain peak symmetry in order to get an accurate reading when processing the observed media/substance. Parker Hannifin, in the development of a line of column end fittings, has incorporated some key features that help to maintain this "peak symmetry" in HPLC columns.

"Under most circumstances in liquid chromatography (LC), the flow through the tube is laminar, the so-called Poiseuille flow, and in this situation the velocity at all points is parallel to the tube axis."

Due to the importance of maintaining smooth laminar flow after injection of the sample into the HPLC column, Parker

incorporated a small conical angle on the fitting body internals. This conical angle helps to equally disperse the sample into the column tube. One of the key requirements of an effective column end fitting is not to delay or disturb the flow of the sample through the instrument (HPLC column).

A second area to address is the minimizing of tube fitting internal "cavities". A cavity is a short section of the flow path where the flow-channel diameter increases. It can occur where tubes are connected to each other (low dead volume connector) or to injectors, columns (column end fittings), and detectors. Large cavities can seriously degrade the resolution of any chromatogram, but they can be easily avoided through awareness of the geometric design details of the fittings and connecting parts manufactured by various companies.

Parker Hannifin has incorporated those critical features in both a low dead volume union connector and the column end fitting bodies. First, the utilization of inverted 1/16" connections to greatly reduce internal volume or cavities. To eliminate any confusion or occurrence of incorrect effective tube make-up, the port depths (body bore dimensions) are identical by size throughout the entire Parker Hannifin instrumentation line. Second, Parker closely monitors the dimensions of the small through-hole utilized in these low dead volume connectors.

## Z2HCZ7, Z2HLZ7 Column End Fitting – Low Internal Volume with Frit

For fractional tube

CPI™ PART NO.	A-LOK® PART NO.	INCHES							INTERNAL OPENING	INTERNAL VOLUME
		T <sub>1</sub> TUBE O.D.	T <sub>2</sub> TUBE O.D.	A	C	D	W HEX			
2-1 Z2HCZ7	2-1 Z2HLZ7	1/8	1/16	1.25	.60	.78	7/16	.013	5.4 x 10 <sup>-4</sup> cc	
4-1 Z2HCZ7	4-1 Z2HLZ7	1/4	1/16	1.35	.70	.84	1/2	.013	1.2 x 10 <sup>-3</sup> cc	
6-1 Z2HCZ7	6-1 Z2HLZ7	3/8	1/16	1.43	.76	.92	5/8	.013	3.8 x 10 <sup>-3</sup> cc	

NOTE: A and C dimensions are typical finger-tight.

Dimensions for reference only, subject to change.

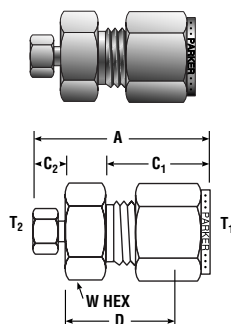

FRIT DESIGNATOR	
* MICRON DASH NO.	MICRON SIZE
-1	0.5 μ
-2	2 μ
-3	5 μ
-4	10 μ

HOW TO ORDER
EXAMPLE: 4-1Z2HLZ7-2*-SS To order with 2μ frit for 1/4" O.D. column

### Features:

- Inverted 1/16" end substantially reduces internal volume
- Flow stream contacts entire frit surface reducing plugging and eliminating unswept volume
- Can be used as a low volume final filter

## Z3HCZ7, Z3HLZ7 Column End Fitting – Low Internal Volume

For fractional tube

CPI™ PART NO.	A-LOK® PART NO.	INCHES							INTERNAL OPENING	INTERNAL VOLUME
		T <sub>1</sub> TUBE O.D.	T <sub>2</sub> TUBE O.D.	A	C	D	W HEX			
4-1 Z3HCZ7	4-1 Z3HLZ7	1/4	1/16	1.28	.70	.77	1/2	.020	6.1 x 10 <sup>-4</sup> cc	
6-1 Z3HCZ7	6-1 Z3HLZ7	3/8	1/16	1.37	.76	.86	5/8	.020	8.1 x 10 <sup>-4</sup> cc	
8-1 Z3HCZ7	8-1 Z3HLZ7	1/2	1/16	1.62	.87	1.00	13/16	.030	2.8 x 10 <sup>-3</sup> cc	
16-1 Z3HCZ7	16-1 Z3HLZ7	1	1/16	2.00	1.05	1.31	1-3/8	.030	2 x 10 <sup>-2</sup> cc	

NOTE: A and C dimensions are typical finger-tight.

Dimensions for reference only, subject to change.

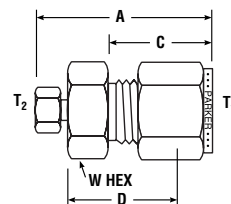

### Features:

- Inverted 1/16" end substantially reduces internal volume
- Drop in frit for use with L.C.\* columns or G.C.\* columns
- Conical angle below frit directs flow over more frit surface
- Available for up to 1" columns

\*G.C. = Gas Chromatograph  
L.C. = Liquid Chromatograph

## Di-Frit (drop in)

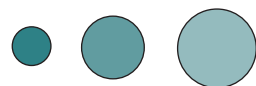

Replaceable frit for preparatory column end fitting Z3HLZ7. Frits are available in 2, 5 and 10 micron sizes.

CPI™/A-LOK® PARKER PART NO.	MICRON SIZE	COLUMN O.D.	PARKER PART NO.	MICRON SIZE	COLUMN O.D.
4DI FRIT-2MIC-SS	2	1/4"	8DI FRIT-2MIC-SS	2	1/2"
4DI FRIT-5MIC-SS	5	1/4"	8DI FRIT-5MIC-SS	5	1/2"
4DI FRIT-10MIC-SS	10	1/4"	8DI FRIT-10MIC-SS	10	1/2"
6DI FRIT-2MIC-SS	2	3/8"	16DI FRIT-2MIC-SS	2	1"
6DI FRIT-5MIC-SS	5	3/8"	16DI FRIT-5MIC-SS	5	1"
6DI FRIT-10MIC-SS	10	3/8"	16DI FRIT-10MIC-SS	10	1"

## Color Coding

For easy reference, table heads are color indicated as follows:

fractional



metric



## ZHCZ7, ZHLZ7 Column End Fitting – Low Internal Volume (without Frit) For fractional tube

CPI™ PART NO.	A-LOK® PART NO.	INTER-CHANGES WITH	INCHES							INTERNAL VOLUME
			T <sub>1</sub> TUBE O.D.	T <sub>2</sub> TUBE O.D.	A	C	D	W HEX	INTERNAL OPENING	
2-1 ZHCZ7	2-1 ZHLZ7	-200-6-1-FGC	1/8	1/16	1.16	.60	.70	7/16	.013	1.0 x 10 <sup>-4</sup> cc
4-1 ZHCZ7	4-1 ZHLZ7	-400-6-1-FGC	1/4	1/16	1.24	.70	.77	1/2	.013	1.1 x 10 <sup>-4</sup> cc
6-1 ZHCZ7	6-1 ZHLZ7	-600-6-1-FGC	3/8	1/16	1.35	.76	.86	5/8	.013	1.3 x 10 <sup>-4</sup> cc

NOTE: A and C dimensions are typical finger-tight. Dimensions for reference only, subject to change.

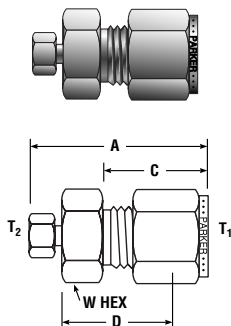

### Features:

- Inverted 1/16" end substantially
- No frit for use with G.C.\* columns or L.C.\* columns with screens
- Can be used as a low volume reducing union

\*G.C. = Gas Chromatograph  
L.C. = Liquid Chromatograph

## Z2HCZ, Z2HLZ Column End Fitting – with Frit For fractional tube

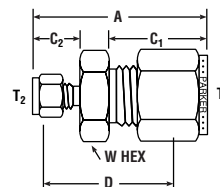
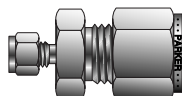

CPI™ PART NO.	A-LOK® PART NO.	INCHES							INTERNAL VOLUME	
		T <sub>1</sub> TUBE O.D.	T <sub>2</sub> TUBE O.D.	A	C <sub>1</sub>	C <sub>2</sub>	D	W HEX		INTERNAL OPENING
2-1 Z2HCZ	2-1 Z2HLZ	1/8	1/16	1.21	.60	.43	.81	7/16	.020	2.1 x 10 <sup>-3</sup> cc
4-1 Z2HCZ	4-1 Z2HLZ	1/4	1/16	1.35	.70	.43	.91	1/2	.020	1.8 x 10 <sup>-3</sup> cc
6-1 Z2HCZ	6-1 Z2HLZ	3/8	1/16	1.44	.76	.43	1.00	5/8	.020	5.4 x 10 <sup>-3</sup> cc

NOTE: A and C dimensions are typical finger-tight. Dimensions for reference only, subject to change.

FRIT DESIGNATOR	
* MICRON DASH NO.	MICRON SIZE
-1	0.5μ
-2	2 μ
-3	5 μ
-4	10 μ

HOW TO ORDER
EXAMPLE: 4-1Z2HLZ-2*-SS To order with 2μ frit for 1/4" O.D. column

NOTE: Size 1 not silver-plated.

### Features:

- Flow stream contacts entire frit surface reducing plugging and eliminating unswept volume
- Can be used as a low volume final filter with drop-in frit

## ZHCZ, ZHLZ Column End Fitting – (without Frit) For fractional tube

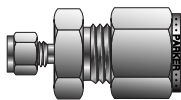

CPI™ PART NO.	A-LOK® PART NO.	INTER- CHANGES WITH	INCHES								INTERNAL VOLUME
			T <sub>1</sub> TUBE O.D.	T <sub>2</sub> TUBE O.D.	A	C <sub>1</sub>	C <sub>2</sub>	D	W HEX	INTERNAL OPENING	
2-1 ZHCZ	2-1 ZHLZ	200-6-1LV	1/8	1/16	1.21	.60	.43	.81	7/16	.020	2.1 x 10 <sup>-3</sup> cc
4-1 ZHCZ	4-1 ZHLZ	400-6-1LV	1/4	1/16	1.35	.70	.43	.91	1/2	.020	2.1 x 10 <sup>-3</sup> cc
6-1 ZHCZ	6-1 ZHLZ	600-6-1LV	3/8	1/16	1.44	.76	.43	1.00	5/8	.020	2.3 x 10 <sup>-3</sup> cc

NOTE: A and C dimensions are typical finger-tight.  
Size 1 Nut is not silver plated

Dimensions for reference only, subject to change.

## Z7HBZ7-SS, Z7HLZ7 Union Connector – Low Dead Volume For fractional tube

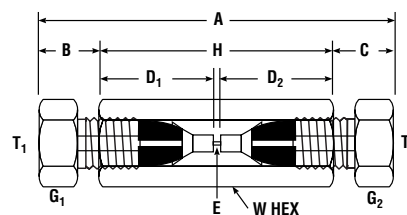

CPI™ PART NO.	A-LOK® PART NO.	INTER- CHANGES WITH	INCHES												INTERNAL VOLUME
			T <sub>1</sub> TUBE O.D.	T <sub>2</sub> TUBE O.D.	†A	†B	†C	D <sub>1</sub>	D <sub>2</sub>	E INTERNAL OPENING	G <sub>1</sub>	G <sub>2</sub>	H	W HEX	
1-1 Z7HBZ7-SS	1-1 Z7HLZ7	IFO-6GC	1/16	1/16	1.26	.21	.21	.41	.41	.013	.25	.25	.84	1/4	8.7 x 10 <sup>-6</sup> cc
2-1 Z7HBZ7-SS	2-1 Z7HLZ7	–	1/8	1/16	1.53	.31	.21	.56	.41	.013	.38	.25	1.02	7/16	8.7 x 10 <sup>-6</sup> cc
2-2 Z7HBZ7-SS	2-2 Z7HLZ7	–	1/8	1/8	1.81	.31	.31	.56	.56	.052	.38	.38	1.19	7/16	9.7 x 10 <sup>-6</sup> cc

†Average Value

Dimensions for reference only, subject to change.

## Color Coding

For easy reference, table heads are color indicated as follows:

fractional



metric





## FBZ7, FLZ7 Male Connector – Low Dead Volume For fractional tube

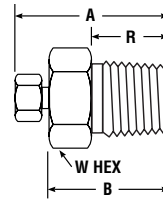
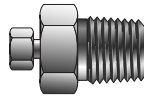

CPI™ PART NO.	A-LOK® PART NO.	INCHES							INTERNAL OPENING	INTERNAL VOLUME
		NPT TUBE O.D.	PIPE THREAD	†A	B	R	W HEX			
1-1 FBZ7	1-1 FLZ7	1/16	1/16	.75	.55	.38	5/16	.013	3.1 x 10 <sup>-4</sup> cc	
1-2 FBZ7	1-2 FLZ7	1/16	1/8	.79	.59	.38	7/16	.013	4.4 x 10 <sup>-4</sup> cc	
1-4 FBZ7	1-4 FLZ7	1/16	1/4	1.01	.81	.56	5/8	.013	8.8 x 10 <sup>-4</sup> cc	

†Average Value

Dimensions for reference only, subject to change.

## ZHBS, ZHLS Sanitary Flange Fitting For fractional tube

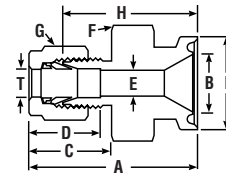
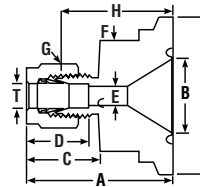

CPI™ PART NO.	PARKER PART NO.	INCHES											
		INTER- CHANGES WITH	TUBE OD	SANITARY FLANGE	A	B	C	D	E MIN. OPENING	F	G HEX FLAT	H	I
4-8 ZHBS	4-8 ZHLS-SS	SS-400-SC-8	1/4	1/2	1.57	.37	.70	.60	.19	1.00	9/16	1.34	.98
4-12 ZHBS	4-12 ZHLS-SS	SS-400-SC-12	1/4	3/4	1.57	.62	.70	.60	.19	1.00	9/16	1.34	.98
4-16 ZHBS	4-16 ZHLS-SS	SS-400-SC-16	1/4	1	1.57	.87	.70	.60	.19	1.38	9/16	1.34	1.98
4-24 ZHBS	4-24 ZHLS-SS	SS-400-SC-24	1/4	1 1/2	1.57	1.37	.70	.60	.19	1.38	9/16	1.28	1.98
6-8 ZHBS	6-8 ZHLS-SS	SS-600-SC-8	3/8	1/2	1.63	.37	.76	.66	.28	1.00	11/16	1.34	.98
6-12 ZHBS	6-12 ZHLS-SS	SS-600-SC-12	3/8	3/4	1.63	.62	.76	.66	.28	1.00	11/16	1.34	.98
6-16 ZHBS	6-16 ZHLS-SS	SS-600-SC-16	3/8	1	1.63	.87	.76	.66	.28	1.38	11/16	1.34	1.98
6-24 ZHBS	6-24 ZHLS-SS	SS-600-SC-24	3/8	1 1/2	1.63	1.37	.76	.66	.28	1.38	11/16	1.34	1.98
8-8 ZHBS	8-8 ZHLS-SS	SS-810-SC-8	1/2	1/2	1.74	.37	.90	.86	.37	1.00	7/8	1.40	.98
8-12 ZHBS	8-12 ZHLS-SS	SS-810-SC-12	1/2	3/4	1.74	.62	.90	.86	.41	1.00	7/8	1.34	.98
8-16 ZHBS	8-16 ZHLS-SS	SS-810-SC-16	1/2	1	1.74	.87	.90	.86	.41	1.38	7/8	1.34	1.98
8-24 ZHBS	8-24 ZHLS-SS	SS-810-SC-24	1/2	1 1/2	1.74	1.37	.90	.86	.41	1.38	7/8	1.34	1.98

NOTE: A, C, and D dimensions are typical finger tight.

Dimensions for reference only, subject to change.

Sanitary flange fittings combine the reliability and versatility of Parker tube fittings with conventional sanitary flanges.

The fittings permit direct downstream connections for hookups and sampling.

Flange sizes are 1/2, 3/4, 1, and 1-1/2 in.

Parker tube fitting ends are available in 1/4, 3/8, and 1/2 in. Parker tube fittings allow use of a variety of tubing materials including metal, hard plastic, and soft plastic.

For a Thermocouple/Bored-Thru™ version of the above Sanitary Adapter fittings, add a "4" to the part number. Example: A 4-12 ZHLS-SS becomes a 4-12 ZH4LS-SS for a 3/4" Sanitary Flange with a 1/4" diameter bored through on the A-LOK® fitting end.

## B2HF, B2HF Barbed Connector to Male Pipe For fractional tube

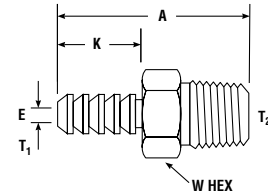
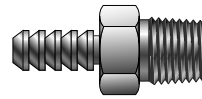

CPI™ PART NO.	A-LOK® PART NO.	INTER- CHANGES WITH	INCHES					
			T <sub>1</sub> HOSE I.D.	T <sub>2</sub> MALE PIPE SIZE	A	E BORE	K	W HEX
2-2 B2HF	2-2 B2HF	2-HC-1-2	1/8	1/8	1.00	.078	.41	7/16
2-4 B2HF	2-4 B2HF	2-HC-1-4	1/8	1/4	1.22	.078	.41	9/16
4-2 B2HF	4-2 B2HF	4-HC-1-2	1/4	1/8	1.41	.188	.75	7/16
4-4 B2HF	4-4 B2HF	4-HC-1-4	1/4	1/4	1.59	.188	.78	9/16
5-2 B2HF	5-2 B2HF	5-HC-1-2	5/16	1/8	1.50	.188	.88	7/16
5-4 B2HF	5-4 B2HF	5-HC-1-4	5/16	1/4	1.69	.250	.88	9/16
6-4 B2HF	6-4 B2HF	6-HC-1-4	3/8	1/4	1.72	.281	.88	9/16
6-6 B2HF	6-6 B2HF	6-HC-1-6	3/8	3/8	1.72	.297	.88	11/16
8-6 B2HF	8-6 B2HF	8-HC-1-6	1/2	3/8	1.81	.375	.94	3/4
8-8 B2HF	8-8 B2HF	8-HC-1-8	1/2	1/2	2.00	.375	.94	7/8
12-12 B2HF	12-12 B2HF	12-HC-1-12	3/4	3/4	2.13	.625	1.03	1-1/16

Dimensions for reference only, subject to change.

## B2HT2, B2TU Barbed Connector to Tube Adapter For fractional tube

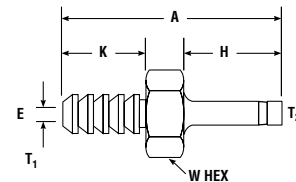
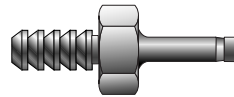

CPI™ PART NO.	A-LOK® PART NO.	INTER- CHANGES WITH	INCHES						
			T <sub>1</sub> HOSE I.D.	T <sub>2</sub> TUBE O.D.	A	E BORE	H	K	W HEX
2-2 B2HT2	2B2TU2	2-HC-A-201	1/8	1/8	1.16	.078	.53	.41	5/16
2-4 B2HT2	2B2TU4	2-HC-A-401	1/8	1/4	1.26	.078	.64	.41	3/8
4-4 B2HT2	4B2TU4	4-HC-A-401	1/4	1/4	1.64	.156	.64	.78	3/8
6-6 B2HT2	6B2TU6	6-HC-A-601	3/8	3/8	1.75	.156	.72	.78	7/16

**NOTE:** Tube adapter end is designed for use with Parker fittings or valves. Simply insert the tube adapter end until it bottoms and tighten the Parker nut 3/4 turns for sizes 3 and below, for sizes 4 and above 1-1/4 turns from finger tight. Add -Z6 for assembly of nuts and ferrules on the tube stub end.

## HCS, HCS Hose Connector Sleeve For fractional tube

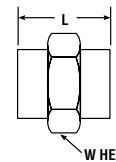

### Color Coding

For easy reference, table heads are color indicated as follows:

#### fractional



#### metric



PARKER PART NO.	INCHES			
	HOSE I.D.	HOSE O.D.	L	W HEX
HCS 2-4	1/8	1/4	.41	3/8
HCS 4-6	1/4	3/8	.78	9/16
HCS 4-7	1/4	7/16	.78	5/8
HCS 4-8	1/4	1/2	.78	11/16
HCS 4-9	1/4	9/16	.78	3/4
HCS 5-7	5/16	7/16	.88	5/8
HCS 6-8	3/8	1/2	.88	11/16
HCS 6-9	3/8	9/16	.88	3/4
HCS 8-11	1/2	11/16	.94	7/8
HCS 12-16	3/4	1	1.06	1-1/4

Dimensions for reference only, subject to change.

## TIZ Insert

For fractional tube

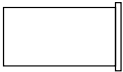

PARKER PART NO.	INTER-CHANGES WITH	INCHES		
		TUBE O.D.	TUBE I.D.	TUBE WALL
3 TIZ (.125)	305-2	3/16	.125	.031
4 TIZ (.125)	405-2	1/4	.125	.062
4 TIZ (.170)	405-170	1/4	.170	.040
4 TIZ (.188)	405-3	1/4	.188	.031
5 TIZ (.125)	505-2	5/16	.125	.094
5 TIZ (.188)	505-3	5/16	.188	.062
5 TIZ (.250)	505-4	5/16	.250	.031
6 TIZ (.188)	605-3	3/8	.188	.094
6 TIZ (.250)	605-4	3/8	.250	.062
8 TIZ (.250)	815-4	1/2	.250	.125
8 TIZ (.375)	815-6	1/2	.375	.062
10 TIZ (.375)	1015-6	5/8	.375	.125
10 TIZ (.500)	1015-8	5/8	.500	.062
12 TIZ (.500)	1215-8	3/4	.500	.125
12 TIZ (.625)	1215-10	3/4	.625	.062
16 TIZ (.750)	1615-12	1	.750	.125
16 TIZ (.875)	1615-14	1	.875	.062

Dimensions for reference only, subject to change.

**NOTE:** The TIZ insert is designed to be used with soft plastic tubing. Tubing wall thickness and corresponding minimum I.D. flow paths are listed so the system designer can properly match the insert to the tubing.

**Example:** 4 TIZ (.125) is used with tubing having a wall thickness of .062 and I.D. of .125.

## TIZ Insert

For metric tube



PARKER PART NO.	INTER-CHANGES WITH	MILLIMETERS		
		TUBE O.D.	TUBE I.D.	TUBE WALL
TIZ 6 (4)	6M5-4M	6	4	1,0
TIZ 8 (6)	8M5-6M	8	6	1,0
TIZ 10 (6)	10M5-6M	10	6	2,0
TIZ 10 (8)	10M5-8M	10	8	1,0
TIZ 12 (8)	12M5-8M	12	8	2,0
TIZ 12 (10)	12M5-10M	12	10	1,0
TIZ 15 (10)	15M5-10M	15	10	2,5

Dimensions for reference only, subject to change.

**NOTE:** The TIZ insert is designed to be used with soft plastic tubing. Tubing wall thickness and corresponding minimum I.D. flow paths are listed so the system designer can properly match the insert to the tubing.

**Example:** TIZ6(4) is used with tubing having a wall thickness of 1mm and I.D. of 4mm.

## BZ, NU Tube Nut

For fractional tube

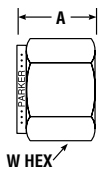

CPI™ PART NO.	A-LOK® PART NO.	INTER-CHANGES WITH	INCHES		
			TUBE O.D.	A	W HEX
1 BZ	1NU1	102-1	1/16	.31	5/16
2 BZ	2NU2	202-1	1/8	.47	7/16
3 BZ	3NU3	302-1	3/16	.47	1/2
4 BZ	4NU4	402-1	1/4	.50	9/16
5 BZ	5NU5	502-1	5/16	.53	5/8
6 BZ	6NU6	602-1	3/8	.56	11/16
8 BZ	8NU8	812-1	1/2	.69	7/8
10 BZ	10NU10	1012-1	5/8	.69	1
12 BZ	12NU12	1212-1	3/4	.69	1-1/8
14 BZ	14NU14	1412-1	7/8	.69	1-1/4
16 BZ	16NU16	1612-1	1	.81	1-1/2
20 BZ	20NU20	2012-1	1-1/4	1.25	1-7/8
24 BZ	24NU24	2412-1	1-1/2	1.50	2-1/4
32 BZ	32NU32	3212-1	2	2.062	3

Dimensions for reference only, subject to change.

**NOTE:** All size 20, 24 and 32 silver plated nuts should have a system compatible lube (Permatex Anti-seize – Parker Catalog 4290-INST) or equivalent applied to the fitting body threads and the inside back of nuts. This will minimize the effort required to assemble the fitting properly.

## BZ, NUM Tube Nut For metric tube

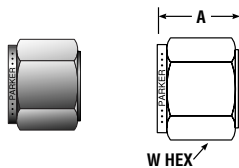

CPI™ PART NO.	A-LOK® PART NO.	INTER- CHANGES WITH	UN THREAD	MILLIMETERS		
				TUBE O.D.	A	W HEX
BZ 2	NUM2	2M2-1	2	5/16-20	11,9	12,0
BZ 3	NUM3	3M2-1	3	5/16-20	11,9	12,0
BZ 4	NUM4	4M2-1	4	3/8-20	11,9	12,0
BZ 6	NUM6	6M2-1	6	7/16-20	12,7	14,0
BZ 8	NUM8	8M2-1	8	1/2-20	13,5	16,0
BZ 10	NUM10	10M2-1	10	5/8-20	15,1	19,0
BZ 12	NUM12	12M2-1	12	3/4-20	17,5	22,0
BZ 14	NUM14	14M2-1	14	7/8-20	17,5	25,0
BZ 15	NUM15	15M2-1	15	7/8-20	17,5	25,0
BZ 16	NUM16	16M2-1	16	7/8-20	17,5	25,0
BZ 18	NUM18	18M2-1	18	1-20	17,5	30,0
BZ 20	NUM20	20M2-1	20	1.1/8-20	17,5	32,0
BZ 22	NUM22	22M2-1	22	1.1/8-20	17,5	32,0
BZ 25	NUM25	25M2-1	25	1.5/16-20	20,6	38,0

Dimensions for reference only, subject to change.

## BZI Inverted Tube Nut For fractional tube

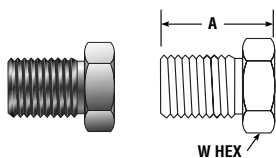

PARKER PART NO.	INTER- CHANGES WITH	INCHES		
		TUBE O.D.	A	W HEX
1 BZI	1F2-1GC	1/16	.39	1/4
2 BZI	2F2-1GC	1/8	.44	7/16

Dimensions for reference only, subject to change.

## BZP Knurled Nut For fractional tube

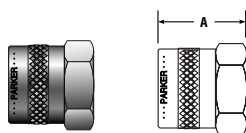

PARKER PART NO.	INTER- CHANGES WITH	INCHES	
		TUBE O.D.	A
1 BZP	102-1K	1/16	.32
2 BZP	202-1K	1/8	.47
3 BZP	302-1K	3/16	.47
4 BZP	402-1K	1/4	.51
5 BZP	502-1K	5/16	.54
6 BZP	812-1K	3/8	.57
8 BZP	602-1K	1/2	.69
10 BZP	1012-1K	5/8	.69

Dimensions for reference only, subject to change.

### HOW TO ASSEMBLE BZP

1. Replace NU nut with BZP nut on Parker A-LOK® fitting body.
2. Insert plastic tubing until it bottoms in fitting body.
3. Tighten finger tight.

The knurled nut is designed for use with soft plastic tubing on low pressure applications where a finger tight assembly procedure is satisfactory.

**Example:** Laboratory test hook-ups. Nylon or Teflon® ferrules are frequently used instead of metal ferrules in this type of application.

## TZ Ferrules



PARKER PART NO.	TUBE O.D. (INCHES)
1 TZ	1/16
2 TZ	1/8
3 TZ	3/16
4 TZ	1/4
5 TZ	5/16
6 TZ	3/8
8 TZ	1/2
10 TZ	5/8
12 TZ	3/4
14 TZ	7/8
16 TZ	1
20 TZ	1-1/4
24 TZ	1-1/2
32 TZ	2

Dimensions for reference only, subject to change.

PARKER PART NO.	TUBE O.D. (INCHES)
TZ 3	
TZ 6	6
TZ 8	8
TZ 10	10
TZ 12	12
TZ 16	16
TZ 20	
TZ 25	

Dimensions for reference only, subject to change.

## INCH

### FF Front Ferrule *For fractional tube*



PARKER PART NO.	INTER-CHANGES WITH	INCHES TUBE O. D.
1FF1	103-1	1/16
2FF2	203-1	1/8
3FF3	303-1	3/16
4FF4	403-1	1/4
5FF5	503-1	5/16
6FF6	603-1	3/8
8FF8	813-1	1/2
10FF10	1013-1	5/8
12FF12	1213-1	3/4
14FF14	1413-1	7/8
16FF16	1613-1	1
20FF20	2013-1	1-1/4
24FF24	2413-1	1-1/2
32FF32	3213-1	2

### BF Back Ferrule *For fractional tube*



PARKER PART NO.	INTER-CHANGES WITH	INCHES TUBE O. D.
1BF1	104-1	1/16
2BF2	204-1	1/8
3BF3	304-1	3/16
4BF4	404-1	1/4
5BF5	504-1	5/16
6BF6	604-1	3/8
8BF8	814-1	1/2
10BF10	1014-1	5/8
12BF12	1214-1	3/4
14BF14	1414-1	7/8
16BF16	1614-1	1
20BF20	2014-1	1-1/4
24BF24	2414-1	1-1/2
32BF32	3214-1	2

For stainless steel, sizes 4-32 are Supercase ferrules.

## METRIC

### FFM Front Ferrule *For metric tube*



PARKER PART NO.	INTER-CHANGES WITH	MM TUBE O. D.
FFM2	2M3-1	2
FFM3	3M3-1	3
FFM4	4M3-1	4
FFM6	6M3-1	6
FFM8	8M3-1	8
FFM10	10M3-1	10
FFM12	12M3-1	12
FFM14	14M3-1	14
FFM15	15M3-1	15
FFM16	16M3-1	16
FFM18	18M3-1	18
FFM20	20M3-1	20
FFM22	22M3-1	22
FFM25	25M3-1	25

### BFM Back Ferrule *For metric tube*



PARKER PART NO.	INTER-CHANGES WITH	MM TUBE O. D.
BFM2	2M4-1	2
BFM3	3M4-1	3
BFM4	4M4-1	4
BFM6	6M4-1	6
BFM8	8M4-1	8
BFM10	10M4-1	10
BFM12	12M4-1	12
BFM14	14M4-1	14
BFM15	15M4-1	15
BFM16	16M4-1	16
BFM18	18M4-1	18
BFM20	20M4-1	20
BFM22	22M4-1	22
BFM25	25M4-1	25

For stainless steel, sizes 6mm-25mm are Supercase ferrules.

### Ferrule Holder

Package simplifies ordering, stocking, and assembling

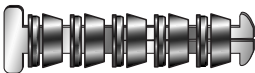

CPI™ PART NO. 1 HOLDER	A-LOK® PART NO. 1 HOLDER	T TUBE O. D. (INCHES)
2 CPI-SET	2 ALOK-SET	1/8
4 CPI-SET	4 ALOK-SET	1/4
6 CPI-SET	6 ALOK-SET	3/8
8 CPI-SET	8 ALOK-SET	1/2
12 CPI-SET	12 ALOK-SET	3/4
16 CPI-SET	16 ALOK-SET	1

\*Material designator – 316-SS, B-Brass, S-Steel

CPI™ PART NO. 1 HOLDER	A-LOK® PART NO. 1 HOLDER	T TUBE O. D. (MM)
6M CPI-SET	6M ALOK-SET	6
8M CPI-SET	8M ALOK-SET	8
10M CPI-SET	10M ALOK-SET	10
12M CPI-SET	12M ALOK-SET	12

\*Material designator – 316-SS, B-Brass, S-Steel

The Parker ferrule holder offers a new convenience. The holder contains individual ferrule sets. Ferrule sets may be dispensed one at a time.

## Color Coding

For easy reference, table heads are color indicated as follows:

fractional



metric



## FNZ, BLP Plug

### For fractional tube

For plugging open ended CPI™/A-LOK® fitting ends

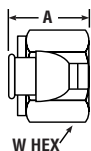

CPI™ PART NO.	A-LOK® PART NO.	INTER-CHANGES WITH	INCHES			
			TUBE O. D.	THREAD	A	W HEX
1 FNZ 2 FNZ 3 FNZ 4 FNZ 5 FNZ	1BLP1 2BLP2 3BLP3 4BLP4 5BLP5	100-P 200-P 300-P 400-P 500-P	1/16 1/8 3/16 1/4 5/16	10-32 5/16-20 3/8-20 7/16-20 1/2-20	.31 .47 .47 .50 .53	5/16 7/16 1/2 9/16 5/8
6 FNZ 8 FNZ 10 FNZ 12 FNZ 14 FNZ	6BLP6 8BLP8 10BLP10 12BLP12 14BLP14	600-P 810-P 1010-P 1210-P 1410-P	3/8 1/2 5/8 3/4 7/8	9/16-20 3/4-20 7/8-20 1-20 1-1/8-20	.56 .69 .69 .69 .69	11/16 7/8 1 1-1/8 1-1/4
16 FNZ 20 FNZ 24 FNZ 32 FNZ	16BLP16 20BLP20 24BLP24 32BLP32	1610-P 2010-P 2410-P 3210-P	1 1-1/4 1-1/2 2	1-5/16-20 1-5/8-20 1-15/16-20 2-5/8-20	.81 1.35 1.72 2.27	1-1/2 1-7/8 2-1/4 3

**HOW TO ASSEMBLE**  
Wrench tighten only 1/4 turn from finger tight position. Assembly includes machined ferrule with lock ring.

Dimensions for reference only, subject to change.

## FNZ, BLPM Plug

### For metric tube

For plugging open ended CPI™/A-LOK® fitting ends

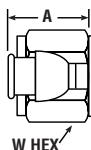

CPI™ PART NO.	A-LOK® PART NO.	INTER-CHANGES WITH	MILLIMETERS			
			TUBE O. D.	THREAD	A	W HEX
FNZ 2 FNZ 3 FNZ 4 FNZ 6 FNZ 8	BLPM2 BLPM3 BLPM4 BLPM6 BLPM8	2MO-P 3MO-P 4MO-P 6MO-P 8MO-P	2 3 4 6 8	5/16-20 5/16-20 3/8-20 7/16-20 1/2-20	11,9 11,9 11,9 12,7 13,5	12,0 12,0 12,0 14,0 16,0
FNZ 10 FNZ 12 FNZ 14 FNZ 15 FNZ 16	BLPM10 BLPM12 BLPM14 BLPM15 BLPM16	10MO-P 12MO-P 14MO-P 15MO-P 16MO-P	10 12 14 15 16	5/8-20 3/4-20 7/8-20 7/8-20 7/8-20	15,1 17,5 17,5 17,5 17,5	19,0 22,0 25,0 25,0 25,0
FNZ 18 FNZ 20 FNZ 22 FNZ 25	BLPM18 BLPM20 BLPM22 BLPM25	18MO-P 20MO-P 22MO-P 25MO-P	18 20 22 25	1-20 1-1/8-20 1-1/8-20 1-5/16-20	17,5 17,5 17,5 20,6	30,0 32,0 32,0 38,0

**HOW TO ASSEMBLE**  
Wrench tighten only 1/4 turn from finger tight position. Assembly includes machined ferrule with lock ring.

Dimensions for reference only, subject to change.

## PNBZ, BLEN Cap

### For fractional tube

For capping open ended tubing

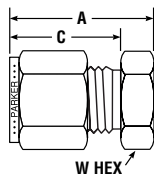
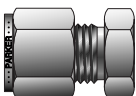

CPI™ PART NO.	A-LOK® PART NO.	INTER-CHANGES WITH	INCHES			
			TUBE O. D.	A	C	W HEX
1 PNBZ 2 PNBZ 3 PNBZ 4 PNBZ 5 PNBZ	1BLEN1 2BLEN2 3BLEN3 4BLEN4 5BLEN5	100-C 200-C 300-C 400-C 500-C	1/16 1/8 3/16 1/4 5/16	.56 .79 .84 .92 .96	.43 .60 .64 .70 .73	5/16 7/16 7/16 1/2 9/16
6 PNBZ 8 PNBZ 10 PNBZ 12 PNBZ 14 PNBZ	6BLEN6 8BLEN8 10BLEN10 12BLEN12 14BLEN14	600-C 810-C 1010-C 1210-C 1410-C	3/8 1/2 5/8 3/4 7/8	1.01 1.15 1.18 1.25 1.31	.76 .87 .87 .87 .87	5/8 13/16 15/16 1-1/16 1-3/16
16 PNBZ 20 PNBZ 24 PNBZ 32 PNBZ	16BLEN16 20BLEN20 24BLEN24 32BLEN32	1610-C 2010-C 2410-C 3210-C	1 1-1/4 1-1/2 2	1.52 2.09 2.53 3.41	1.05 1.52 1.77 2.47	1-3/8 1-3/4 2-1/8 2-3/4

**NOTE:** For body only specify PNZ.  
A and C dimensions are typical finger-tight.

Dimensions for reference only, subject to change.

## PNBZ, BLENM Cap

### For metric tube

For capping open ended tubing

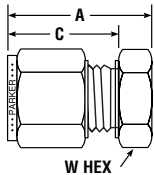
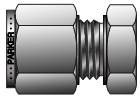

CPI™ PART NO.	A-LOK® PART NO.	INTER- CHANGES WITH	MILLIMETERS			
			TUBE O.D.	A	C	W HEX
PNBZ 2	BLENM2	2MO-C	2	13,5	15,3	12,0
PNBZ 3	BLENM3	3MO-C	3	13,5	15,3	12,0
PNBZ 4	BLENM4	4MO-C	4	14,3	16,1	12,0
PNBZ 6	BLENM6	6MO-C	6	15,9	17,7	14,0
PNBZ 8	BLENM8	8MO-C	8	17,1	18,6	15,0
PNBZ 10	BLENM10	10MO-C	10	19,1	19,5	18,0
PNBZ 12	BLENM12	12MO-C	12	19,1	22,0	22,0
PNBZ 14	BLENM14	14MO-C	14	19,8	22,0	24,0
PNBZ 15	BLENM15	15MO-C	15	19,8	22,0	24,0
PNBZ 16	BLENM16	16MO-C	16	19,8	22,0	24,0
PNBZ 18	BLENM18	18MO-C	18	21,3	22,0	27,0
PNBZ 20	BLENM20	20MO-C	20	23,9	22,0	30,0
PNBZ 22	BLENM22	22MO-C	22	23,9	22,0	30,0
PNBZ 25	BLENM25	25MO-C	25	26,2	26,5	35,0

**NOTE:** For body only specify PNZ.  
A and C dimensions are typical finger-tight.

Dimensions for reference only, subject to change.

## MDF Vent Protector NPT Male Pipe Thread

### For fractional tube

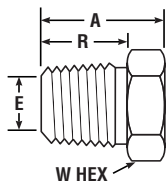

PARKER PART NO.	INTER- CHANGES WITH	INCHES				
		THREAD SIZE	A	R	E MINIMUM OPENING	W HEX FLAT
2 MDF	MS-MD-2M	1/8-27	.63	.38	.19	9/16
4 MDF	MS-MD-4M	1/4-18	.81	.56	.28	9/16
6 MDF	MS-MD-6M	3/8-18	.81	.56	.41	11/16
8 MDF	MS-MD-8M	1/2-14	1.06	.75	.50	7/8
12 MDF	MS-MD-12M	3/4-14	1.13	.75	.63	1-1/16
16 MDF	MS-MD-16M	1-11-1/2	1.31	.95	.94	1-3/8

Dimensions for reference only, subject to change.

Parker Instrumentation vent protectors (mud dauber fittings) protect open ends of instruments, tubing, outlet vents, etc. The mesh wire screen prevents foreign bodies such as insects or debris from entering and clogging various systems and causing damage.

- pipe plug, bored-thru design
- 40 x 40 mesh, .010 diameter wire screen
- designed to vent female pipe, straights, elbows or tees.

## Color Coding

For easy reference, table heads are color indicated as follows:

### fractional



### metric



## SEALING WASHERS

### Bonded Seals

Consists of an outer stainless steel ring with a Fluorocarbon® inner ring used to seal a male ISO parallel thread.

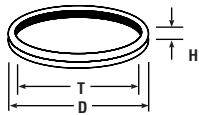

PARKER PART NO.	T BSPP THREAD	D	H
M30201-SS	1/8	.63	.08
M30202-SS	1/4	.81	.08
M30203-SS	3/8	.94	.08
M30204-SS	1/2	1.12	.10
M30206-SS	3/4	1.38	.10
M30208-SS	1	1.69	.10

PRESSURE RATINGS FOR SEALING WASHERS		
THREAD SIZE	PSI	BAR
1/8	5300	370
1/4	5500	380
3/8	4400	300
1/2	4000	280
3/4	3700	260
1	2800	190

These seals are also available in steel with a nitrile inner ring. Simply replace Suffix SS with S

Dimensions for reference only, subject to change.

### Copper Washers

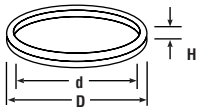

For BSPP male thread sealing

PARKER PART NO.	THREAD	D	d	H
M28329-CU	1/8	.71	.39	.09
M28330-CU	1/4	.87	.55	.09
M28331-CU	3/8	.94	.67	.09
M28332-CU	1/2	1.18	.87	.10
M28334-CU	3/4	1.38	1.06	.09
M28336-CU	1	1.65	1.34	.09

For BSPP female thread sealing

PARKER PART NO.	THREAD	D	d	H
M25179-CU	1/8	.322	.218	.062
M25180-CU	1/4	.436	.312	.062
M25181-CU	3/8	.574	.437	.062
M25182-CU	1/2	.719	.562	.062
M25184-CU	3/4	.935	.812	.062
M25186-CU	1	1.178	1.000	.093

Used to provide a seal with male or female parallel ISO threads.

Dimensions for reference only, subject to change.

Please note the pressure ratings are based on taper threaded ends. The pressure rating for the BSPP ends are dependent on the type of sealing washer used.

### Color Coding

For easy reference, table heads are color indicated as follows:

**fractional**



**metric**





## WLZ Bulkhead Locknut

For fractional tube

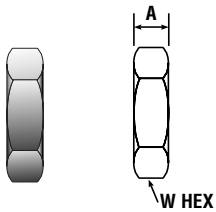

PARKER PART NO.	INTER-CHANGES WITH	INCHES			
		A-LOK® THREAD	TUBE O. D.	A	W HEX
1 WLZ	102-61	10-32	1/16	.13	5/16
2 WLZ	202-61	5/16-20	1/8	.19	1/2
3 WLZ	302-61	3/8-20	3/16	.22	9/16
4 WLZ	402-61	7/16-20	1/4	.22	5/8
5 WLZ	502-61	1/2-20	5/16	.23	11/16
6 WLZ	602-61	9/16-20	3/8	.25	3/4
8 WLZ	812-61	3/4-20	1/2	.28	15/16
10 WLZ	1012-61	7/8-20	5/8	.31	1-1/16
12 WLZ	1212-61	1"-20	3/4	.34	1-3/16
14 WLZ	1412-61	1-1/8-20	7/8	.38	1-3/8
16 WLZ	1612-61	1-5/16-20	1	.38	1-5/8

Dimensions for reference only, subject to change.

## WLN Bulkhead Locknut

For fractional tube

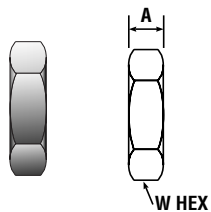

PARKER PART NO.	INCHES			
	SAE ADJ. STR. THREAD	TUBE O. D.	A	W HEX
4 WLN	7/16-20	1/4	.28	11/16
6 WLN	9/16-18	3/8	.27	13/16
8 WLN	3/4-16	1/2	.31	1
12 WLN	1-1/16-12	3/4	.41	1-3/8
16 WLN	1-5/16-12	1	.41	1-5/8

Dimensions for reference only, subject to change.

## BN Bulkhead Locknut

For metric tube

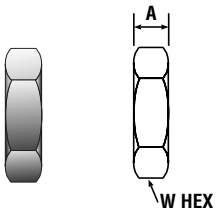

PARKER PART NO.	MILLIMETERS			
	SAE ADJ. STR. THREAD	TUBE O. D.	A	W HEX
2BN2	5/16-20	2 & 3	4,8	13,0
3BN3	3/8-20	4	5,6	14,0
4BN4	7/16-20	6	5,6	16,0
5BN5	1/2-20	8	5,6	17,0
BNM10	5/8-20	10	6,4	21,0
8BN8	3/4-20	12	7,1	24,0
10BN10	7/8-20	14, 15 & 16	7,9	27,0
12BN12	1-20	18	8,6	30,0
14BN14	1-1/8-20	20 & 22	9,7	33,0
16BN16	1-5/16-20	25	9,7	41,0

Dimensions for reference only, subject to change.

## L5N Accessory Locknut

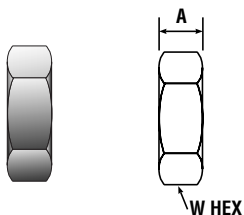

PARKER PART NO.	INCHES		
	STRAIGHT THREAD	A	W HEX
2 L5N	5/16-24	.22	7/16
3 L5N	3/8-24	.22	1/2
4 L5N	7/16-20	.28	9/16
5 L5N	1/2-20	.28	5/8
6 L5N	9/16-18	.28	11/16
8 L5N	3/4-16	.31	7/8
10 L5N	7/8-14	.36	1
12 L5N	1-1/16-12	.41	1-1/4
14 L5N	1-3/16-12	.41	1-3/8
16 L5N	1-5/16-12	.41	1-1/2

Dimensions for reference only, subject to change.

NOTE: For use with M2SC and M2TU fittings on pages 54 and 55.

## Assembly and Remake Instructions

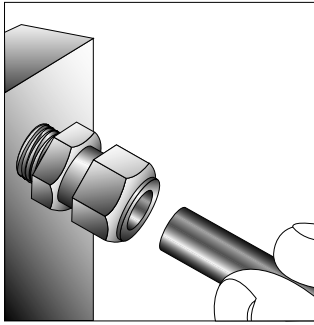

INCH SIZE 1 thru 3  
(1/16" - 3/16")  
METRIC SIZE 2 thru 4  
(2-4mm)

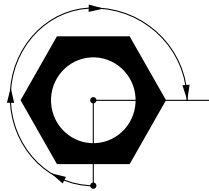

Only 3/4 turn from finger tight is necessary to seal and will result in additional remakes of the fitting

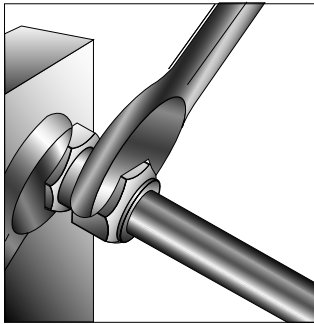

INCH SIZE 4 thru 16  
(1/4" - 1")  
METRIC SIZE 6 thru 25  
(6-25mm)

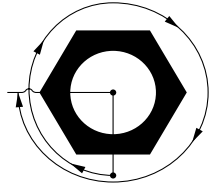

1-1/4 Turns from Finger Tight

1. Parker instrument tube fittings are sold completely assembled and ready for immediate use. Simply insert the tube as illustrated until it bottoms in the fitting body. (If the fitting is disassembled, note that the small tapered end of the ferrule(s) go into the fitting body.)

2. Tighten nut finger tight. Then tighten nut with wrench an additional 1-1/4 turns indicated below. Hold fitting body with a second wrench to prevent body from turning. It is helpful to mark the nut to facilitate counting the number of turns.

For maximum number of remakes, mark the fitting and nut before disassembly. Before retightening, make sure the assembly has been inserted into the fitting until the ferrule seats in the fitting. Retighten the nut by hand. Rotate the nut with a wrench to the original position as indicated by the previous marks lining up. (A noticeable increase in mechanical resistance will be felt indicating the ferrule is being re-sprung into sealing position.)

Only after several remakes will it become necessary to advance the nut slightly past the original position. This advance (indicated by B) need only be 10°-20° (less than 1/3 of a hex flat).

**For Sizes above 16 (1"), the Parker IPD Hydraulic Presetting Tool or Rotary Wrench Tool should be used. Cat. 4290-INST.**

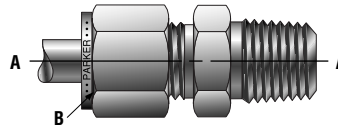

Parker CPI™/A-LOK® Tube Fitting part numbers use symbols to identify the size, style, and material. Tube and pipe thread sizes begin with a number indicating their size in sixteenths of an inch. For example, 4=4/16" or 1/4"; 16=16/16" or 1.

**NOTE:** Lubrication of the nut is **REQUIRED** for proper assembly on all **LARGER** size fittings in both inch and metric sizes. This requirement applies to:

- inch sizes of 20 and higher
- metric sizes of 25 and higher

For additional information please contact your local authorized Parker Instrumentation distributor or call Parker Instrumentation Products Division and ask for Bulletin 4230-B10.

## Gaugeability Instructions

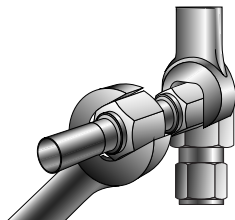

1. From "finger tight" position, wrench 1-1/4 turns for 1/4" to 1" size fittings (6mm to 25mm) (1/16", 1/8", 3/16", 2mm 3mm and 4mm size tube fittings only wrench 3/4 turn from finger tight position). Hold fitting body hex with second wrench to prevent body from turning as you tighten. It is a good idea to mark the nut (scribe or ink) to help you count the turns.

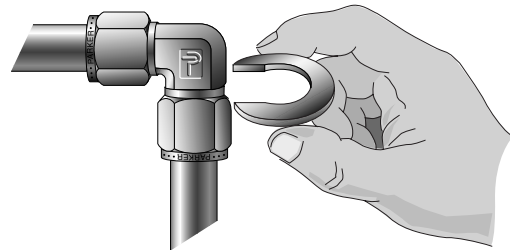

2. Now select the proper size inspection gauge and try to place it, as shown, between the nut and the body hex. If gauge **DOES NOT FIT AT ANY POINT** between them, you have correctly tightened the nut. If you can slip the gauge into the space, the fitting is not properly made up, and you must repeat the assembly procedure.

For additional information please contact your local authorized Parker Instrumentation distributor or call Parker Instrumentation Products Division and ask for Bulletin 4230-B15.2.

## Instrument Tubing Selection Guide

Parker's instrument tube fittings have been designed to work in a wide variety of applications that demand the utmost in product performance.

Although Parker's Instrument tube fittings have been engineered and manufactured to consistently provide this level of reliability, no systems in-tegrity is complete without considering the critical link, tubing.

This booklet is intended to assist the designer to properly select and order quality tubing.

Proper tube selection and installation, we believe, are key ingredients in building leak-free reliable tubing systems.

### General Selection Criteria

The most important consideration in the selection of suitable tubing for any application is the compatibility of the tubing material with the media to be contained. [Table 1](#) lists common materials and their associated general application. [Table 1](#) also lists the maximum and minimum operating temperature for the various tubing materials.

In addition, Parker instrument fittings are designed to work on like materials. Stainless steel fittings should be used only with stainless steel tubing, aluminum fittings with aluminum tubing, etc. The practice of mixing materials is strongly discouraged. The only exception is brass fittings with copper tubing.

Dissimilar materials in contact may be susceptible to galvanic corrosion. Further, different materials have different levels of hardness, and can adversely affect the fittings ability to seal on the tubing.

TUBING MATERIAL	GENERAL APPLICATION	RECOMMENDED TEMPERATURE RANGE
Stainless Steel	High Pressure, High Temperature, Generally Corrosive Media	-425°F to 1,200°F <sup>1</sup> (-255°C to 605°C)
Carbon Steel	High Pressure, High Temperature Oil, Air, Some Specialty Chemicals	-20°F to 800°F <sup>2</sup> (-29°C to 425°C)
Copper	Low Temperature, Low Pressure Water, Oil, Air	-40°F to 400°F (-40°C to 205°C)
Aluminum	Low Temperature, Low Pressure Water, Oil, Air, Some Specialty Chemicals	-40°F to 400°F (-40°C to 205°C)
Monel 400™	Recommended for Sour Gas Applications Well Suited for Marine and General Chemical Processing Applications	-325°F to 800°F (-198°C to 425°C)
Alloy C276	Excellent Corrosion Resistance to Both Oxidizing and Reducing Media and Excellent Resistance to Localized Corrosion Attack	-325°F to 1000°F (-198°C to 535°C)
Carpenter 20™	Applications Requiring Resistance to Stress Corrosion Cracking in Extreme Conditions	-325°F to 800°F (-198°C to 425°C)
Alloy 600	Recommended for High Temperature Applications with Generally Corrosive Media	-205°F to 1200°F (-130°C to 650°C)
Titanium	Resistant to Many Natural Environments such as Sea Water, Body Fluids and Salt Solutions	-75°F to 600°F (-59°C to 315°C)

Carpenter 20 is a trademark of Carpenter Technology Corporation.

Monel 400 is a trademark of International Nickel.

- For operating temperatures above 800 °F (425 °C), consideration should be given to media. 300 Series Stainless Steels are susceptible to carbide precipitation which may lead to intergranular corrosion at elevated temperatures.
- Consideration should be given to maximum temperature ratings if fittings and/or tubing are coated or plated.  
All temperature ratings based on temperatures per ASME/ANSI B31-3 Chemical Plant and Petroleum Refinery Piping Code, 1999 Edition.  
The information listed in Table 1 is general in scope. For specific applications, please contact Parker's Instrumentation Products Division, Product Engineering Department (256) 881-2040.

## Gas Service

Special care must be taken when selecting tubing for gas service. In order to achieve a gas-tight seal, ferrules in instrument fittings must seal any surface imperfections. This is accomplished by the ferrules penetrating the surface of the tubing. Penetration can only be achieved if the tubing provides radial resistance and if the tubing material is softer than the ferrules.

Thick walled tubing helps to provide resistance. Tables 2-7 indicate the minimum acceptable wall thickness for various materials in gas service. The ratings in white indicate combination of diameter and wall thickness which are suitable for gas service.

Acceptable tubing hardness for general application is listed in Table 9. These values are the maximum allowed by ASTM. For gas service, better results can be obtained by using tubing well below this maximum hardness. For example, a desirable hardness of 80 Rb is suitable for stainless steel. The maximum allowed by ASTM is 90 Rb.

## System Pressure

The system operating pressure is another important factor in determining the type, and more importantly, the size of tubing to be used. In general, high pressure installations require strong materials such as steel or stainless steel. Heavy walled softer tubing such as copper may be used if chemical compatibility exists with the media. However, the higher strength of steel or stainless steel permits the use of thinner tubes without reducing the ultimate rating of the system. In any event, tube fitting assemblies should never be pressurized beyond the recommended working pressure.

The following tables (2-7) list by material the maximum suggested working pressure of various tubing sizes. Acceptable tubing diameters and wall thicknesses are those for which a rating is listed. Combinations, which do not have a pressure rating, are not recommended for use with instrument fittings.

### MAXIMUM ALLOWABLE WORKING PRESSURE TABLES

Table 2		316 or 304 STAINLESS STEEL (Seamless)														
Tube O.D. Size	Wall Thickness															
	0.010	0.012	0.014	0.016	0.020	0.028	0.035	0.049	0.065	0.083	0.095	0.109	0.120	0.134	0.156	0.188
1/16	5600	6900	8200	9500	12100	16800										
1/8						8600	10900									
3/16						5500	7000	10300								
1/4						4000	5100	7500	10300							
5/16							4100	5900	8100							
3/8							3300	4800	6600							
1/2							2600	3700	5100	6700						
5/8								3000	4000	5200	6100					
3/4								2400	3300	4300	5000	5800				
7/8								2100	2800	3600	4200	4900				
1									2400	3200	3700	4200	4700			
1-1/4										2500	2900	3300	3700	4100	4900	
1-1/2											2400	2700	3000	3400	4000	4500
2												2000	2200	2500	2900	3200

Table 3		316 or 304 STAINLESS STEEL (Welded)														
Tube O.D. Size	Wall Thickness															
	0.010	0.012	0.014	0.016	0.020	0.028	0.035	0.049	0.065	0.083	0.095	0.109	0.120	0.134	0.156	0.188
1/16	4800	5900	7000	8100	10300	14300										
1/8						7300	9300									
3/16						4700	6000	8700								
1/4						3400	4400	6400	8700							
5/16							3400	5000	6900							
3/8							2800	4100	5600							
1/2							2200	3200	4300	5700						
5/8								2500	3400	4500	5200					
3/4								2100	2800	3700	4200	4900				
7/8								1800	2400	3100	3600	4200				
1									2100	2700	3100	3600	4000			
1-1/4										2100	2400	2800	3100	3500	4200	
1-1/2											2000	2300	2600	2900	3400	4200
2												1700	1900	2100	2500	3000

Tube O.D. Size	0.028	0.035	0.049	0.065	0.083	0.095	0.109	0.120	0.134	0.148	0.165	0.180
1/8	8100	10300										
3/16	5200	6700	9700									
1/4	3800	4900	7100	9700								
5/16		3800	5500	7700								
3/8		3100	4500	6200								
1/2		2300	3300	4500	6000							
5/8		1800	2600	3500	4600	5400						
3/4			2200	2900	3800	4400	5100					
7/8			1800	2500	3200	3700	4300					
1			1600	2100	2800	3200	3700	4100				
1-1/4				1700	2200	2500	2900	3200	3700	3800		
1-1/2					1800	2100	2400	2700	3000	3400	3800	4000
2						1600	1800	2000	2200	2500	2800	3000

Tube O.D. Size	0.035	0.049	0.065	0.083	0.095
1/8	8700				
3/16	5600	8100			
1/4	4100	5900			
5/16	3200	4600			
3/8	2600	3800			
1/2	1900	2800	3800		
5/8	1500	2200	2900		
3/4		1800	2400	3200	
7/8		1500	2100	2700	
1		1300	1800	2300	2700

Tube O.D. Size	0.010	0.020	0.028	0.035	0.049	0.065	0.083	0.095	0.109	0.120
1/16	1700	3800	5400	6000						
1/8			2800	3600						
3/16			1800	2300	3500					
1/4				1700	2600	3500				
5/16				1300	2000	2800				
3/8				1100	1600	2300				
1/2				800	1200	1600	2200			
5/8					900	1300	1700	2000		
3/4					800	1000	1400	1600	1900	
7/8					600	900	1100	1300	1600	
1					600	800	1000	1200	1400	1500
1-1/8						700	900	1000	1200	1300

Tube O.D. Size	0.010	0.020	0.028	0.035	0.049	0.065	0.083	0.095	0.109	0.120
1/16	5900	12600	17000							
1/8			8600	11000						
3/16			5500	7100	10300					
1/4			4000	5100	7500	10300				
5/16				4000	5900	8100				
3/8				3300	4800	6600				
1/2				2300	3300	4500	5900			
5/8					2800	3700	4900	5700		
3/4					2300	3100	4000	4600	5400	
1						2300	2900	3400	3900	4400

**Note:** • All working pressures have been calculated using the maximum allowable stress levels in accordance with ANSI B31.3, Chemical Plant and Petroleum Refinery Piping Code, 1999 Edition.

- All calculations are based on maximum outside diameter and minimum wall thickness.
- All working pressures are ambient (72°F or 22°C) temperature.

## System Temperature

Operating temperature is another factor in determining the proper tubing material. Copper and aluminum tubing are suitable for low temperature media. Stainless steel and carbon steel tubing are suitable for higher temperature media. Special alloys such as Alloy 600 are recommended for extremely high temperatures (see Table 1). Table 8 lists derating factors which should be applied to the working pressures listed in Tables 2-7 for elevated temperature conditions. Simply locate the correct factor in Table 8 and multiply this by the appropriate value in Tables 2-7 for elevated temperature working pressure.

Temperature °F (°C)	Copper	Aluminum	316 SS	304 SS	Steel	Monel 400
100 (38)	1.00	1.00	1.00	1.00	1.00	1.00
200 (93)	.80	1.00	1.00	1.00	.96	.88
300 (149)	.78	.81	1.00	1.00	.90	.82
400 (204)	.50	.40	.97	.94	.86	.79
500 (260)			.90	.88	.82	.79
600 (316)			.85	.82	.77	.79
700 (371)			.82	.80	.73	.79
800 (427)			.80	.76	.59	.76
900 (486)			.78	.73		
1000 (538)			.77	.69		
1100 (593)			.62	.49		
1200 (649)			.37	.30		

**EXAMPLE:** 1/2 inch x .49 wall seamless 316 stainless steel tubing has a working pressure of 3700 psi @ room temperature. If the system were to operate @ 800°F (425°C), a factor of 80% or (.80) would apply (see Table 8 above) and the "at temperature" system pressure would be 3700 PSI x .80 = 2960 PSI.

## Tubing Ordering Suggestions

Tubing for use with Parker instrument fittings must be carefully ordered to insure adequate quality for good performance. Each purchase order must specify the material nominal outside diameter, and wall thickness. Ordering to ASTM specifications insures that the tubing will be dimensionally, physically, and chemically within strict limits. Also, more stringent requirements may be added by the user. All tubing should be ordered free of scratches and suitable for bending.

A purchase order meeting the above criteria would read as follows:

"1/2 x .049 316 stainless steel, seamless, or welded and redrawn per ASTM A-249. Fully annealed, 80 Rb or less. Must be suitable for bending; surface scratches, and imperfections (incomplete weld seams) are not permissible."

Table 9 lists specific ordering information for each material.

Material	Type	ASTM Tubing Spec.	Condition	Max. Recommended Hardness
Stainless Steel	304, 316, 316L	ASTM-A-269, A-249, A-213, A632	Fully Annealed	90 Rb
Copper	K or L	ASTM-B75 B68, B88 (K or L)*	Soft Annealed Temper 0	60 Max. Rockwell 15T
Carbon Steel	1010	SAE-J524b, J525b ASTM-A-179	Fully Annealed	72 Rb
Aluminum	Alloy 6061	ASTM B-210	T6 Temper	56 Rb
Monel™	400	ASTM B-165	Fully Annealed	75 Rb
Alloy C-276	C-276	ASTM-B-622, B-626	Fully Annealed	90 Rb
Alloy 600	600	ASTM B-167	Fully Annealed	90 Rb
Carpenter 20™	20CB-3	ASTM B-468	Fully Annealed	90 Rb
Titanium	Commercially Pure Grade 2	ASTM B-338	Fully Annealed	99 Rb 200 Brinell Typical

\* Note: B88 Copper Tube to be ordered non-engraved

## Pipe Pressure Ratings

NPT / BSPT Pipe Size	BRASS			
	Male		Female	
	Straight <sup>a</sup>	Shape <sup>b</sup>	Straight <sup>a</sup>	Shape <sup>b</sup>
1/16	6000	5500	4500	3800
1/8	5600	5000	4000	2900
1/4	4100	4100	4300	3000
3/8	4000	4000	3500	2700
1/2	3900	3100	3600	2500
3/4	3800	3400	3000	2000
1	2700	2700	3100	2300
1-1/4	2000	2000	2300	1900
1-1/2	1800	1800	2100	1700
2	1600	1600	2000	1500

NPT / BSPT Pipe Size	STAINLESS STEEL			
	Male		Female	
	Straight <sup>a</sup>	Shape <sup>b</sup>	Straight <sup>a</sup>	Shape <sup>b</sup>
1/16	10000	9500	7500	7000
1/8	9100	9100	6400	5500
1/4	7500	7500	6600	5600
3/8	7200	7200	5300	5000
1/2	6600	5800	5200	4500
3/4	6400	6400	4300	3500
1	4600	4600	4500	3900
1-1/4	3500	3500	3500	3100
1-1/2	2900	2900	3200	2500
2	2600	2600	2700	2300

NPT / BSPT Pipe Size	CARBON STEEL			
	Male		Female	
	Straight <sup>a</sup>	Shape <sup>b</sup>	Straight <sup>a</sup>	Shape <sup>b</sup>
1/16	10500	10100	8000	7500
1/8	9700	9700	6800	5900
1/4	8000	8000	7000	6000
3/8	7600	7600	5600	5300
1/2	7000	6200	5500	4800
3/4	6800	6800	4600	3700
1	4900	4900	4800	4200
1-1/4	3700	3700	3700	3300
1-1/2	3100	3100	3400	2600
2	2800	2800	2800	2400

### Notes:

- a. Fittings manufactured from bar stock.
- b. Fittings manufactured from forgings.
- c. Material of construction in accordance with Parker Catalog 4230/4233, [Table 1](#).
- d. Pressure ratings for fittings with both tube and pipe ends are rated to the lower pressure.

## NPT Thread

## Straight Thread

## Tubing O.D. Size

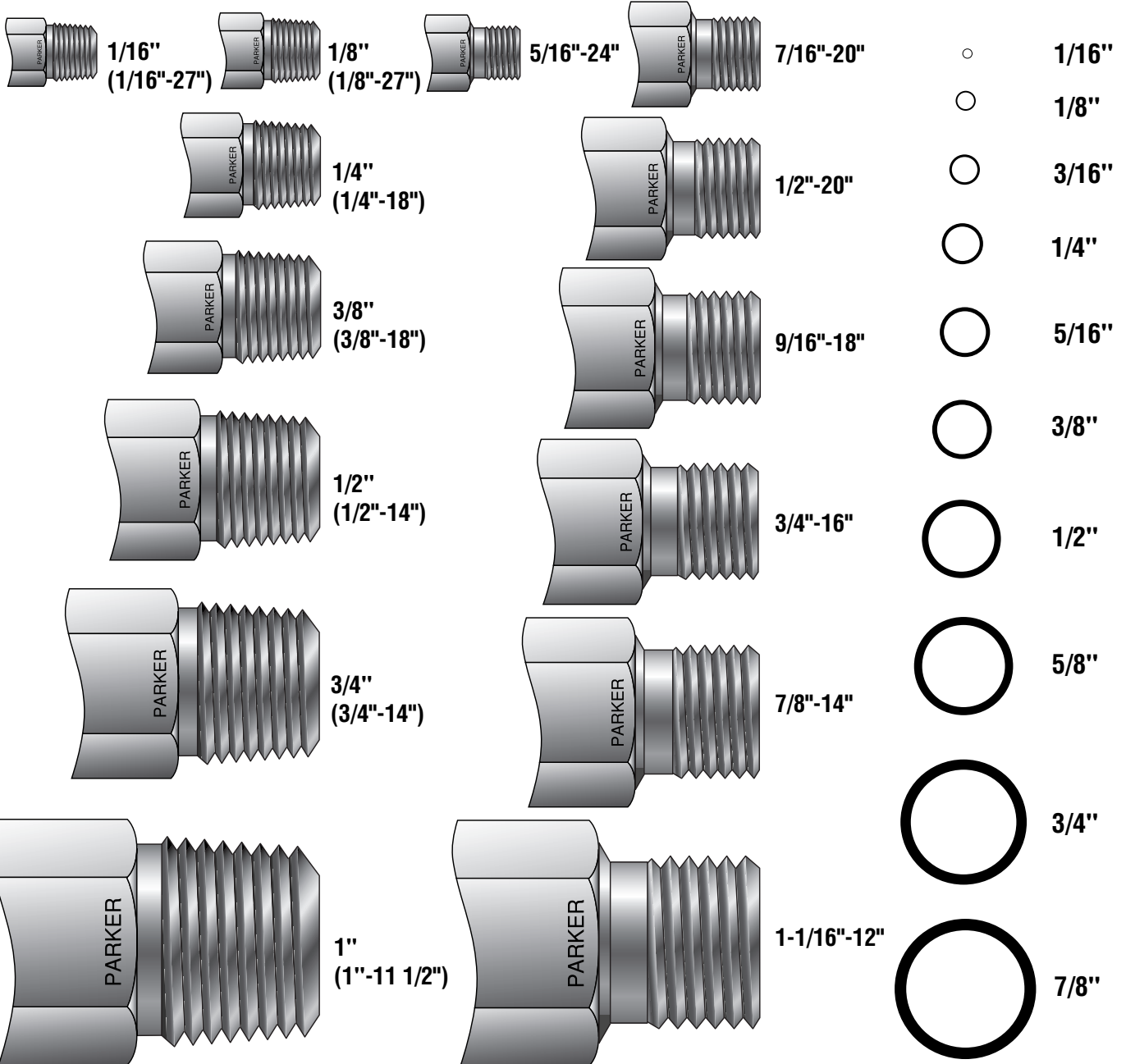

### American Standard Pipe Thread (NPT)

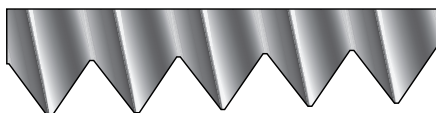

- 60° thread angle • Pitch measured in inches
- Truncation of root and crest are flat
- Taper angle 1°47'

### American Standard Unified Thread (Straight)

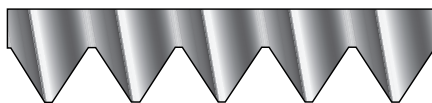

- 60° thread angle • Pitch measured in inches
- Truncation of root and crest are flat
- Diameter measured in inches

## NPT Thread

## Tubing O.D. Size

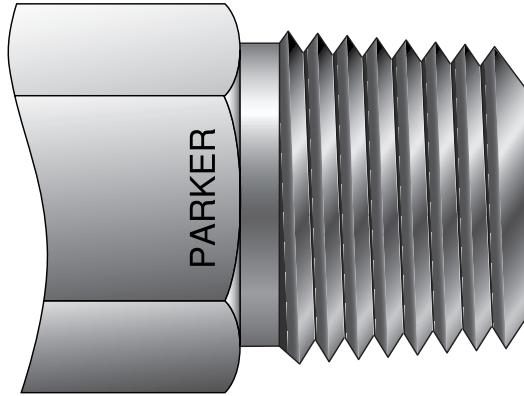

1-1/4"  
(1-1/4" - 1 1/2")

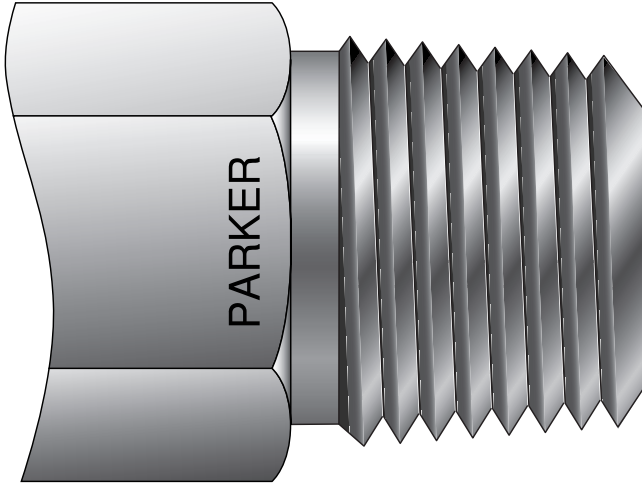
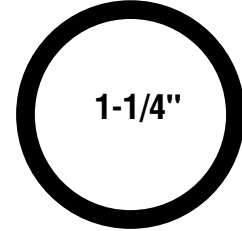

1-1/2"  
(1-1/2" - 1 1/2")

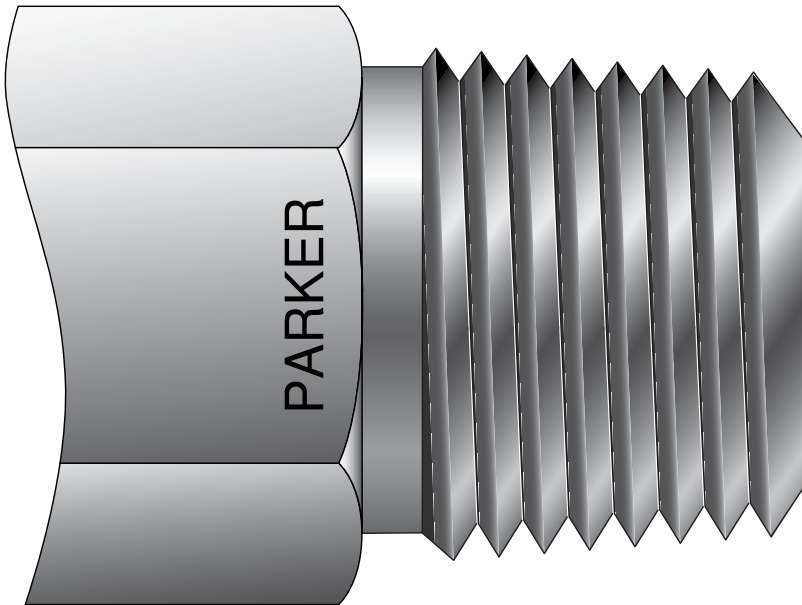
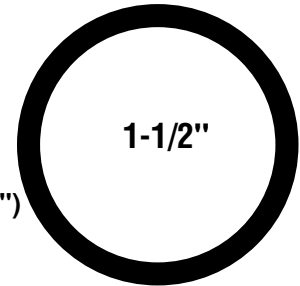

2"  
(2" - 1 1/2")

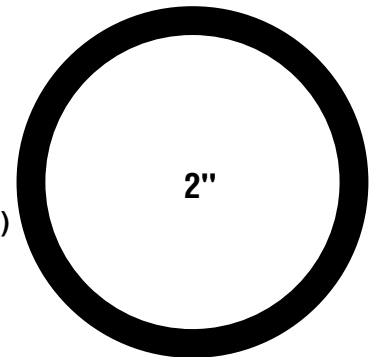















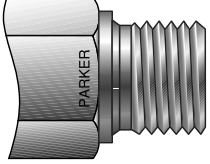

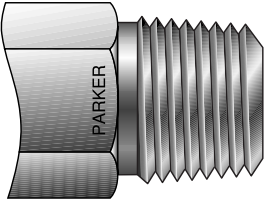
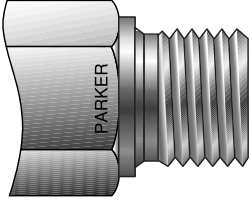

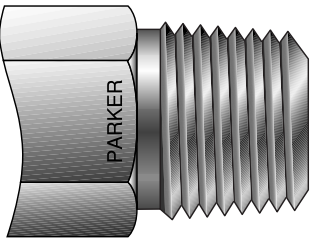
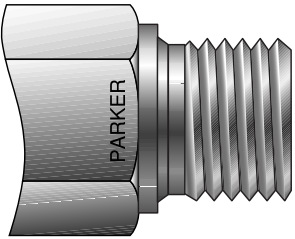

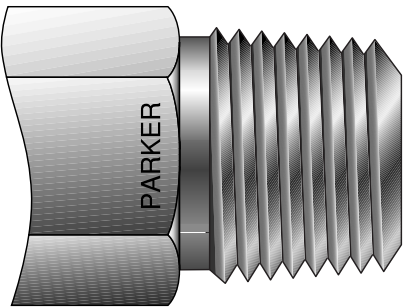
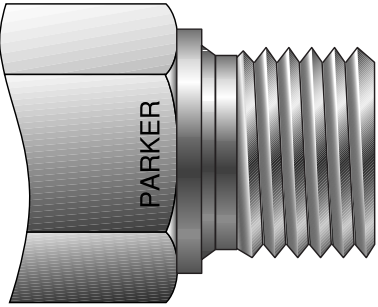



## BSPT Tapered Thread

## BSPP Parallel Thread

## Tubing O.D. Size

	<b>1/8"</b> (1/8"-28")		<b>1/8"</b> (1/8"-28")		<b>2mm</b>
	<b>1/4"</b> (1/4"-19")		<b>1/4"</b> (1/4"-19")		<b>3mm</b>
	<b>3/8"</b> (3/8"-19")		<b>3/8"</b> (3/8"-19")		<b>4mm</b>
	<b>1/2"</b> (1/2"-14")		<b>1/2"</b> (1/2"-14")		<b>6mm</b>
	<b>3/4"</b> (3/4"-14")		<b>3/4"</b> (3/4"-14")		<b>8mm</b>
	<b>1"</b> (1"-11")		<b>1"</b> (1"-11")		<b>10mm</b>
					<b>12mm</b>
					<b>14mm</b>
					<b>15mm</b>
					<b>16mm</b>
					<b>18mm</b>
					<b>20mm</b>
					<b>22mm</b>
					<b>25mm</b>

### International Organization for Standards (ISO 7/1)

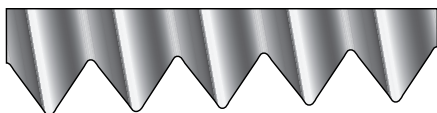

- 55° thread angle • Pitch measured in inches
- Truncation of root and crest are round
- Taper angle 1°47'

### (ISO 228/1)

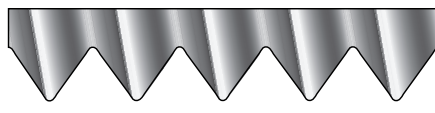

- 55° thread angle • Pitch measured in inches
- Truncation of root and crest are round
- Diameter measured in inches

The items described in this document and other documents or descriptions provided by Parker Hannifin Corporation, its subsidiaries and its authorized distributors are hereby offered for sale at prices to be established by Parker Hannifin Corporation, its subsidiaries and its authorized distributors. This offer and its acceptance by any customer ("Buyer") shall be governed by all of the following Terms and Conditions. Buyer's order for any such items, when communicated to Parker Hannifin Corporation, its subsidiary or an authorized distributor ("Seller") verbally or in writing, shall constitute acceptance of this offer.

**1. Terms and Conditions of Sale:** All descriptions, quotations, proposals, offers, acknowledgments, acceptances and sales of Seller's products are subject to and shall be governed exclusively by the terms and conditions stated herein. Buyer's acceptance of any offer to sell is limited to these terms and conditions. Any terms or conditions in addition to, or inconsistent with those stated herein, proposed by Buyer in any acceptance of an offer by Seller, are hereby objected to. No such additional, different or inconsistent terms and conditions shall become part of the contract between Buyer and Seller unless expressly accepted in writing by Seller. Seller's acceptance of any offer to purchase by Buyer is expressly conditional upon Buyer's assent to all the terms and conditions stated herein, including any terms in addition to, or inconsistent with those contained in Buyer's offer. Acceptance of Seller's products shall in all events constitute such assent.

**2. Payment:** Payment shall be made by Buyer net 30 days from the date of delivery of the items purchased hereunder. Amounts not timely paid shall bear interest at the maximum rate permitted by law for each month or portion thereof that the Buyer is late in making payment. Any claims by Buyer for omissions or shortages in a shipment shall be waived unless Seller receives notice thereof within 30 days after Buyer's receipt of the shipment.

**3. Delivery:** Unless otherwise provided on the face hereof, delivery shall be made F.O.B. Seller's plant. Regardless of the method of delivery, however, risk of loss shall pass to Buyer upon Seller's delivery to a carrier. Any delivery dates shown are approximate only and Seller shall have no liability for any delays in delivery.

**4. Warranty:** Seller warrants that items sold hereunder shall be free from defects in material or workmanship. **THIS WARRANTY COMPRISES THE SOLE AND ENTIRE WARRANTY PERTAINING TO ITEMS PROVIDED HEREUNDER. SELLER MAKES NO OTHER WARRANTY, GUARANTEE, OR REPRESENTATION OF ANY KIND WHATSOEVER. ALL OTHER WARRANTIES, INCLUDING BUT NOT LIMITED TO, MERCHANTABILITY AND FITNESS FOR PURPOSE, WHETHER EXPRESS, IMPLIED, OR ARISING BY OPERATION OF LAW, TRADE USAGE, OR COURSE OF DEALING ARE HEREBY DISCLAIMED.**

**NOTWITHSTANDING THE FOREGOING, THERE ARE NO WARRANTIES WHATSOEVER ON ITEMS BUILT OR ACQUIRED WHOLLY OR PARTIALLY, TO BUYER'S DESIGNS OR SPECIFICATIONS.**

**5. Limitation Of Remedy: SELLER'S LIABILITY ARISING FROM OR IN ANY WAY CONNECTED WITH THE ITEMS SOLD OR THIS CONTRACT SHALL BE LIMITED EXCLUSIVELY TO REPAIR OR REPLACEMENT OF THE ITEMS SOLD, AT SELLER'S SOLE OPTION. IN NO EVENT SHALL SELLER BE LIABLE FOR ANY INCIDENTAL, CONSEQUENTIAL OR SPECIAL DAMAGES OF ANY KIND OR NATURE WHATSOEVER, INCLUDING BUT NOT LIMITED TO LOST PROFITS ARISING FROM OR IN ANY WAY CONNECTED WITH THIS AGREEMENT OR ITEMS SOLD HEREUNDER, WHETHER ALLEGED TO ARISE FROM BREACH OF CONTRACT, EXPRESS OR IMPLIED WARRANTY, OR IN TORT, INCLUDING WITHOUT LIMITATION, NEGLIGENCE, FAILURE TO WARN OR STRICT LIABILITY.**

**6. Changes, Reschedules and Cancellations:** Buyer may request to modify the designs or specifications for the items sold hereunder as well as the quantities and delivery dates thereof, or may request to cancel all or part of this order, however, no such requested modification or cancellation shall become part of the contract between Buyer and Seller unless accepted by Seller in a written amendment to this Agreement. Acceptance of any such requested modification or cancellation shall be at Seller's discretion, and shall be upon such terms and conditions as Seller may require.

**7. Special Tooling:** A tooling charge may be imposed for any special tooling, including without limitation, dies, fixtures, molds and patterns, acquired to manufacture items sold pursuant to this contract. Such special tooling shall be and remain Seller's property notwithstanding payment of any charges by Buyer. In no event will Buyer acquire any interest in apparatus belonging to Seller which is utilized in the manufacture of the items sold hereunder, even if such apparatus has been specially converted or adapted for such manufacture and not withstanding any charges paid by Buyer. Unless otherwise agreed, Seller shall have the right to alter, discard or otherwise dispose of any special tooling or other property in its sole discretion at any time.

**8. Buyer's Property:** Any designs, tools, patterns, materials, drawings, confidential information or equipment furnished by Buyer or any other items which become Buyer's property, may be considered obsolete and may be destroyed by Seller after two (2) consecutive years have elapsed without Buyer placing an order for the items which are manufactured using such property, Seller shall not be responsible for any loss or damage to such property while it is in Seller's possession or control.

**9. Taxes:** Unless otherwise indicated on the face hereof, all prices and charges are exclusive of excise, sales, use, property, occupational or like taxes which may be imposed by any taxing authority upon the manufacture, sale or delivery of the items sold hereunder. If any such taxes must be paid by Seller or if Seller is liable for the collection of such tax, the amount thereof shall be in addition to the amounts for the items sold. Buyer agrees to pay all such taxes or to reimburse Seller therefore upon receipt of its invoice. If Buyer claims exemption from any sales, use or other tax imposed by any taxing authority, Buyer shall save Seller harmless from and against any such tax, together with any interest or penalties thereon which may be assessed if the items are held to be taxable.

**10. Indemnity For Infringement of Intellectual Property Rights:** Seller shall have no liability for infringement of any patents, trademarks, copyrights, trade dress, trade secrets or similar rights except as provided in this Part 10. Seller will defend and indemnify Buyer against allegations of infringement of U.S. Patents, U.S. Trademarks, copyrights, trade dress and trade secrets (hereinafter 'Intellectual Property Rights'). Seller will defend at its expense and will pay the cost of any settlement or damages awarded in an action brought against Buyer based on an allegation that an item sold pursuant to this contract infringes the Intellectual Property Rights of a third party. Seller's obligation to defend and indemnify Buyer is contingent on Buyer notifying Seller within ten (10) days after Buyer becomes aware of such allegations of infringement, and Seller having sole control over the defense of any allegations or actions including all negotiations for settlement or compromise. If an item sold hereunder is subject to a claim that it infringes the Intellectual Property Rights of a third party, Seller may, at its sole expense and option, procure for Buyer the right to continue using said item, replace or modify said item so as to make it noninfringing, or offer to accept return of said item and return the purchase price less a reasonable allowance for depreciation. Notwithstanding the foregoing, Seller shall have no liability for claims of infringement based on information provided by Buyer, or directed to items delivered hereunder for which the designs are specified in whole or part by Buyer, or infringements resulting from the modification, combination or use in a system of any item sold hereunder. The foregoing provisions of this Part 10 shall constitute Seller's sole and exclusive liability and Buyer's sole and exclusive remedy for infringement of Intellectual Property Rights.

If a claim is based on information provided by Buyer or if the design for an item delivered hereunder is specified in whole or in part by Buyer, Buyer shall defend and indemnify Seller for all costs, expenses or judgments resulting from any claim that such item infringes any patent, trademark, copyright, trade dress, trade secret or any similar right.

**11. Force Majeure:** Seller does not assume the risk of and shall not be liable for delay or failure to perform any of Seller's obligations by reason of circumstances beyond the reasonable control of Seller (hereinafter 'Events of Force Majeure'). Events of Force Majeure shall include without limitation, accidents, acts of God, strikes or labor disputes, acts, laws, rules or regulations of any government or government agency, fires, floods, delays or failures in delivery of carriers or suppliers, shortages of materials and any other cause beyond Seller's control.

**12. Entire Agreement/Governing Law:** The terms and conditions set forth herein, together with any amendments, modifications and any different terms or conditions expressly accepted by Seller in writing, shall constitute the entire Agreement concerning the items sold, and there are no oral or other representations or agreements which pertain thereto. This Agreement shall be governed in all respects by the law of the State of Ohio. No actions arising out of the sale of the items sold hereunder or this Agreement may be brought by either party more than two (2) years after the cause of action accrues.

11/98-P



**Parker Hannifin Corporation**  
6035 Parkland Blvd.  
Cleveland, Ohio 44124-4141  
Telephone: (216) 896-3000  
Fax: (216) 896-4000  
www.parker.com

## **Parker Hannifin Corporation**

### **About Parker Hannifin Corporation**

Parker Hannifin is a leading global motion-control company dedicated to delivering premier customer service. A Fortune 500 corporation listed on the New York Stock Exchange (PH), our components and systems comprise over 1,400 product lines that control motion in some 1,000 industrial and aerospace markets. Parker is the only manufacturer to offer its customers a choice of hydraulic, pneumatic, and electromechanical motion-control solutions. Our company has the largest distribution network in its field, with over 7,500 distributors serving nearly 400,000 customers worldwide.

### **Parker's Charter**

To be a leading worldwide manufacturer of components and systems for the builders and users of durable goods. More specifically, we will design, market and manufacture products controlling motion, flow and pressure. We will achieve profitable growth through premier customer service.

### **Product Information**

North American customers seeking product information, the location of a nearby distributor, or repair services will receive prompt attention by calling the Parker Product Information Center at our toll-free number: 1-800-C-PARKER (1-800-272-7537). In Europe, call 00800-C-PARKER-H (00800-2727-5374).

**The Aerospace Group** is a leader in the development, design, manufacture and servicing of control systems and components for aerospace and related high-technology markets, while achieving growth through premier customer service.



**The Climate & Industrial Controls Group** designs, manufactures and markets system-control and fluid-handling components and systems to refrigeration, air-conditioning and industrial customers worldwide.



**The Fluid Connectors Group** designs, manufactures and markets rigid and flexible connectors, and associated products used in pneumatic and fluid systems.

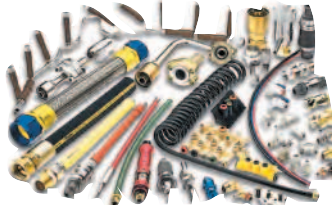

**The Seal Group** designs, manufactures and distributes industrial and commercial sealing devices and related products by providing superior quality and total customer satisfaction.



**The Hydraulics Group** designs, produces and markets a full spectrum of hydraulic components and systems to builders and users of industrial and mobile machinery and equipment.



**The Filtration Group** designs, manufactures and markets quality filtration and clarification products, providing customers with the best value, quality, technical support, and global availability.



**The Automation Group** is a leading supplier of pneumatic and electromechanical components and systems to automation customers worldwide.



**The Instrumentation Group** is a global leader in the design, manufacture and distribution of high-quality critical flow components for worldwide process instrumentation, ultra-high-purity, medical and analytical applications.





**Parker Hannifin Corporation**  
Instrumentation Products Division  
1005 A Cleaner Way  
Huntsville, AL 35805  
USA  
Phone: (256) 881-2040  
Fax: (256) 881-5072  
[www.parker.com/ipdus](http://www.parker.com/ipdus)

**Parker Hannifin plc**  
Instrumentation Products Division  
Riverside Road  
Pottington Business Park  
Barnstaple, Devon EX31 1NP  
England  
Phone: +44 (0)1271 313131  
Fax: +44 (0)1271 373636  
Email: [ipd@parker.com](mailto:ipd@parker.com)  
[www.parker.com/ipd](http://www.parker.com/ipd)